



KBDPTZ1

PTZ Controller



Please read this manual thoroughly before operation and keep it handy for further reference.

WARNING & CAUTION

	CAUTION RISK OF ELECTRIC SHOCK DO NOT OPEN	
CAUTION : TO REDUCE THE RISK OF ELECTRIC SHOCK DO NOT REMOVE COVER (OR BACK). NO USER SERVICEABLE PARTS INSIDE REFER SERVICING TO QUALIFIED SERVICE PERSONNEL.		



The lightning flash with an arrowhead symbol, within an equilateral triangle is intended to alert the user to the presence of un-insulated "dangerous voltage" within the product's enclosure that may be of sufficient magnitude to constitute a risk of electric shock to persons



The exclamation point within an equilateral triangle is intended to alert the user to the presence of important operating and maintenance (servicing) instructions in the literature accompanying the appliance

INFORMATION -This equipment has been tested and found to comply with limits for a class A digital device Pursuant to part 15 of the FCC rules. These limits are designed to provide reasonable protection against harmful interference when the equipment is operated in a commercial environment. This equipment generates, uses, and can radiate radio frequency energy and if not installed and used in accordance with the instruction manual, may cause harmful interference to radio communications. Operation of this equipment in a residential area is likely to cause harmful interference in which case the user will be required to correct the interference at his own expense.

WARNING – Change or modification not expressly approved by the manufacturer could void the user's authority to operate the equipment

CAUTION : To prevent electric shock and risk of fire hazards.

DO NOT use power sources other than that specified.

DO NOT expose this appliance to rain or moisture.

This installation should be made by a qualified service person and should conform to all local codes.

⚠️ IMPORTANT SAFEGUARDS

1. READ AND RETAIN INSTRUCTIONS

Read the instruction manual before operating the equipment. Retain the manual for future reference.

2. CLEANING

Turn the unit off and unplug from the power outlet before cleaning. Use a damp cloth for cleaning. Do not use harsh cleansers or aerosol cleaners.

3. ATTACHMENTS

Do not use attachments unless recommended by manufacturer as they may affect the functionality of the unit and result in the risk of fire, electric shock or injury.

4. MOISTURE

Do not use equipment near water or other liquids.

5. ACCESSORIES

Equipment should be installed in a safe, stable location. Any wall or shelf mounting accessory equipment should be installed using the manufacturer's instructions. Care should be used when moving heavy equipment. Quick stops, excessive force, and uneven surfaces may cause the equipment to fall causing serious injury to persons and objects.

6. VENTILATION

Openings in the equipment, if any, are provided for ventilation to ensure reliable operation of the unit and to protect it from overheating. These openings must not be blocked or covered.

7. POWER SOURCES

The equipment should be operated only from the type of power source indicated on the marking label. If you are not sure of the type of power supplied at the installation location, contact your dealer. For equipment designed to operate from battery power, refer to the operating instructions.

8. GROUNDING OR POLARIZATION

Equipment that is powered through a polarized plug (a plug with one blade wider than the other) will fit into the power outlet only one way. This is a safety feature. If you are unable to insert the plug fully into the outlet, try reversing the plug. Do not defeat the safety purpose of the polarized plug.

Alternate Warning: If the equipment is powered through a three way grounding type plug, a plug having a third (grounding) pin, will only fit into a grounding-type power outlet. This is a safety feature. Do not defeat the safety purpose of the grounding type plug. If your outlet does not have the grounding plug receptacle, contact your local electrician.

9. CORD AND CABLE PROTECTION

Route power cords and cables in a manner to protect them from damage by being walked on or pinched by items placed upon or against them.

10. LIGHTNING

For protection of the equipment during a lightning storm or when it is left unattended and unused for long periods of time, unplug the unit from the wall outlet. Disconnect any antennas or cable systems that may be connected to the equipment. This will prevent damage to the equipment due to lightning or power line surges.

11. OVERLOADING

Do not overload wall outlets and extension cords as this can result in a risk of fire or electric shock.

12. SERVICING

Do not attempt to service the video monitor or equipment yourself as opening or removing covers may expose you to dangerous voltage or other hazards. Refer all servicing to qualified service personnel.

13. DAMAGE REQUIRING SERVICE

Unplug the equipment from the wall outlet and refer servicing to qualified service personnel under the following conditions:

- When the power supply cord or the plug has been damaged.
- If liquid has spilled or objects have fallen into the unit.
- If the equipment has been exposed to water or other liquids.
- If the equipment does not operate normally by following the operating instructions, adjust only those controls that are covered by the operating instructions. Improper adjustment of other controls may result in damage to the unit.
- If the equipment has been dropped or the casing damaged.
- When the equipment exhibits a distinct change in performance.

14. REPLACEMENT PARTS

When replacement parts are required, be sure the service technician uses replacement parts specified by the manufacturer or that have the same characteristics as the original part. Unauthorized substitutions may result in fire, electric shock, or other hazards.

15. SAFETY CHECK

Upon completion of any service or repairs to the equipment, ask the service technician to perform safety checks to verify that the equipment is in proper operating condition.

16. FIELD INSTALLATION

The installation of equipment should be made by a qualified service person and should conform to all local codes.

☛ TABLE OF CONTENTS

CHAPTER 1 INTRODUCTION

In This Manual	06
Features	06
Before installation	06
Hardware Overview	07
System Configuration and Wiring	09

CHAPTER 2 SYSTEM INSTALLATION & TYPICAL APPLICATIONS

System Installation	10
PTZ SETUP	10
MAIN SETUP	11
JOYSTICK CALIBRATION	12
EASY SETTING FUNCTION (E.S.F)	13
SPECIFICATIONS	13



⌘ LIMITATION OF LIABILITY

THE INFORMATION IN THIS PUBLICATION IS BELIEVED TO BE ACCURATE IN ALL RESPECTS, HOWEVER, WE CANNOT ASSUME RESPONSIBILITY FOR ANY CONSEQUENCES RESULTING FROM THE USE THERE OF. THE INFORMATION CONTAINED HEREIN IS SUBJECT TO CHANGE WITHOUT NOTICE. REVISIONS OR NEW EDITIONS TO THIS PUBLICATION MAY BE ISSUED TO INCORPORATE SUCH CHANGES.

❖ CHAPTER 1 INTRODUCTION

In This Manual

Overview | This manual covers the operation of the KBDPTZ1 keyboard.

KBDPTZ1

This remote keyboard is an accessory for PTZ dome camera, etc.
It allows the user to control from 1 to 255 cameras.

Features

- Controls from 1 ~ 255 cameras.
- Multiple protocol supported in each channel
- RS 485/RS-422 communication (Tx : 3 port , Trx :1 port).
- Programmable user preferences. (preset, tour, group, etc.).
- Built-in 3-Axis proportional joystick
- Easy upload programmed data via serial communication port of PC.
- Built-in 2 lines character LCD.
- User password support.
- Designed for desktop use
- programmable transmission speed for each ID. (2.4~57.6kbps)

Note: units should be set to the communication protocol and the same baud rate.

Before installation

This keyboard system must be installed by qualified service and installation personnel.

Perform the following steps to install the keyboard system.

- A. Unpack all components.
- B. Place the keyboard in a convenient location.

Note: *Carefully and completely read the manuals for each piece of equipment before attempting to install and connect the equipment.*

- C. Decide on the configuration method.
- D. Use one of the following sections to configure the wiring.

CHAPTER 1 INTRODUCTION

Hardware Overview

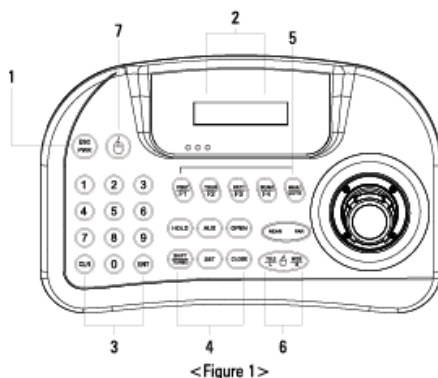

Hardware Components | This remote keyboard contains easy to use control keys on the front and simple input and output connectors on the back.

Control Buttons & Connection | The unit provides the primary operator interface. Most operations are one or two button presses. The following Table contains a description for each buttons on the keyboard and port of cable connection. Use Figure 1 and Figure 2 as a reference.



Number	Button	Description
1	ESC/POWER 	Pressing the ESC/POWER button enters the Power on/off or escape key. Right description led on (red). Pressing it again exits the POWER OFF. (Push the button (about 2-3 seconds) and then POWER OFF)
2	LCD DISPLAY 	Displays Camera ID, Protocol, function status, general status, etc.
3	Numbers 	Camera ID setting value change ,PTZ setup (1+), Main setup (2+)
4	Controller Function keys 	Hold : System locking (Unlocking : Input the Pass word 4 digit *****) SHIFT/TURBO : SHIFT-Key for special function (Customize)/ TURBO -High Speed AUX : External equipment on/off SET : Ptz and main setup (1 +) , (2+) IRES CLOSE : Camera Iris close IRIS OPEN : Camera Iris open
5	Function keys 	F1 - MENU/AUTO : Function Keys (Preset, Tour, Pattern, Scan, Auto). MENU :Used for Camera (Pan/Tilt) Menu adjustment.



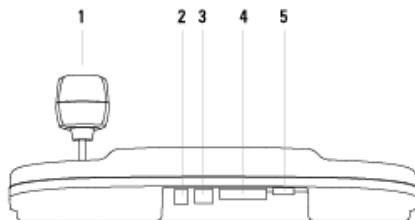

❖ CHAPTER 1 INTRODUCTION

Control buttons (continued)		
Number	Button	Description
6		Camera Focus control
		Camera Zoom control
7		MOUSE ON/OFF (MOUSE FUNCTION KEY 2-3 Seconds push) MOUSE CHARACTER DESCRIPTION WILL BE DISPLAY

[WDS FEL-D 2.0]
ID : 001 MOUSE



<Figure 2>

Number	Item	Description
1	 Joystick	Telemetry Joystick 8Bit allows precise control of Pan/Tilt/Zoom
2	 DC 12V Input	DC 12V Input, 140 mA
3	 USB PORT	Universal Serial Bus Port, USB Mouse function (External Equipment communication port)
4	 TRx Tx3 Tx2 Tx1 RS-485	RS-485/RS-422 communications. (Tx/Rx : 3 port , Trx :1 port)
5	Program	Download connector (For Program Update)

CHAPTER 1 INTRODUCTION

System Configuration and Wiring

Basic Installation

Use the Keyboard Configuration when only one keyboard is connected to the controlled units.
Connect the RS-485 output port of Remote keyboard to RS-485 input port of the first controlled unit using the terminal block

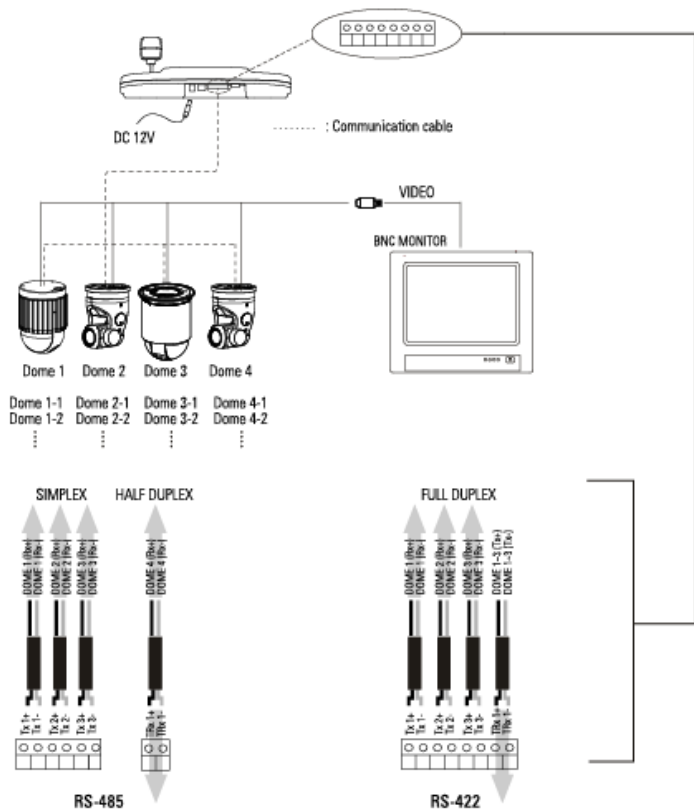

<RS-422/RS-485 Connection Diagram>

❖ CHAPTER 2 SYSTEM INSTALLATION & TYPICAL APPLICATIONS

System Installation

Keyboard Installation

Before you start connecting the keyboard equipment to your system, make sure the units to be controlled are completely installed and everything is working correctly. Before use of this keyboard, you should set the protocol and baud rate (2.4~57.6kbps) in the PTZ SETUP mode. Use the following steps to set the communication protocol and baud rate.

PTZ SETUP

PTZ SETUP

PTZ Setup mode, select 1+(2~3 seconds) setup screen allows you to make change each programmable clause.

Note: The baud rate must be the same between the controlled unit and the keyboard.

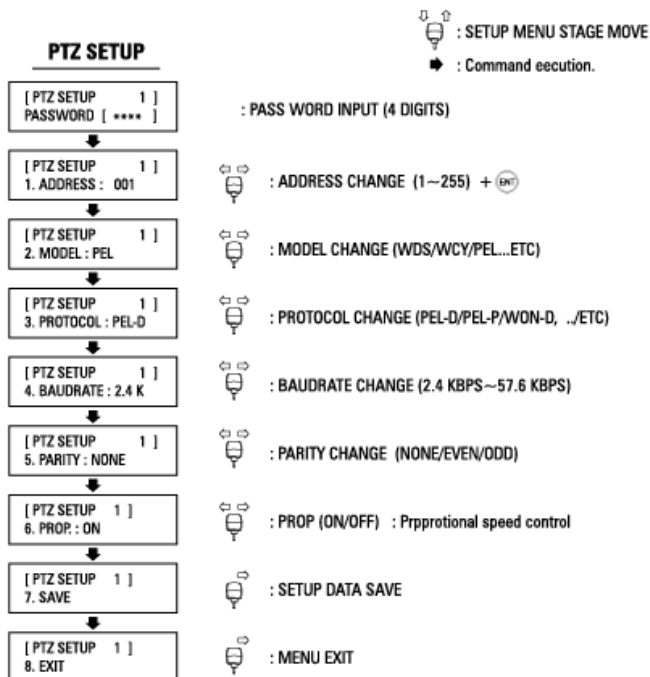

❖ CHAPTER 2 SYSTEM INSTALLATION & TYPICAL APPLICATIONS

MAIN SETUP

MAIN SETUP

Main Setup mode, select 2+  (2~3 seconds)

setup screen allows you to make change each programmable clause.

Note: The baud rate must be the same between the controlled unit and the keyboard.

MAIN SETUP

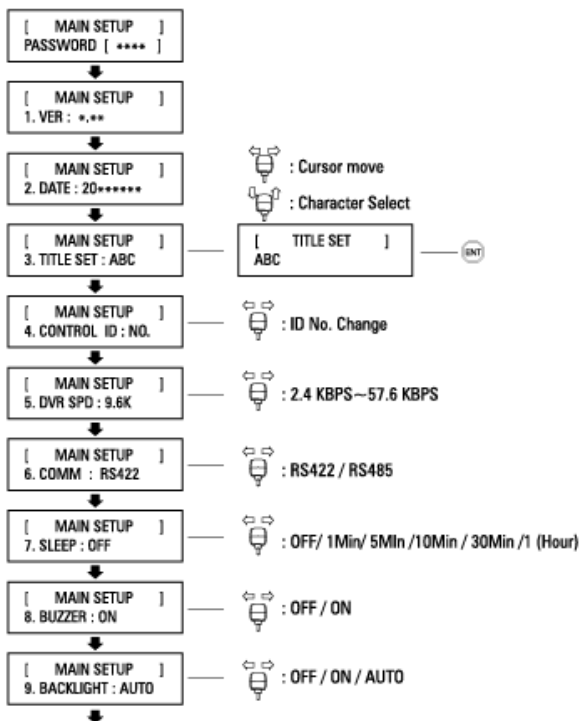

CHAPTER 2 SYSTEM INSTALLATION & TYPICAL APPLICATIONS

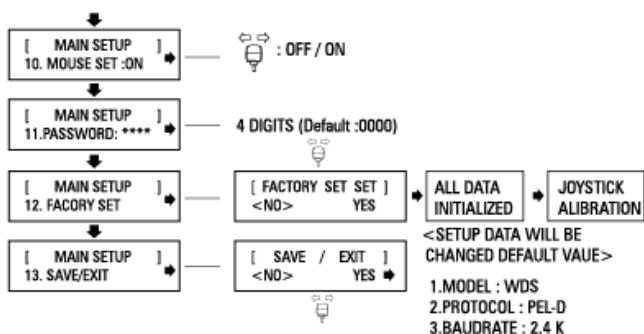

JOYSTICK CALIBRATION

It is for the keyboard to set the Max. movement of joystick
CALIBRATION METHOD : JOYSTICK MOVE (POSITION VALUE) + \odot

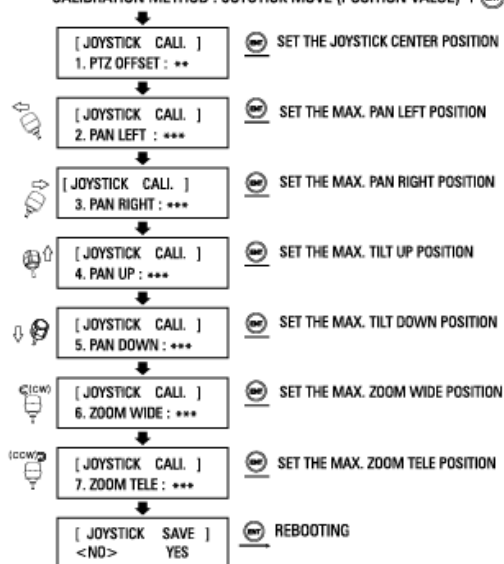

❖ CHAPTER 2 SYSTEM INSTALLATION & TYPICAL APPLICATIONS

EASY SETTING FUNCTION (E.S.F)

EASY SETTING FUNCTION (Number key + Function key)

Number key + PSET/TOUR/PATT/SCAN/ E.S.F

is current position data (pan, tilt, focus, zoom data) save or call of Dome memory

DATA SAVE (SET)

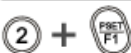

(PSET button 2 seconds push) ➡ Current Position Saved Preset No 2

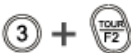

(TOUR button 2 seconds push) ➡ TOUR MENU CALL OF DOME

DATA CALL (GOTO)

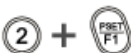

(PSET button push) ➡ No 2 Preset position execution

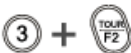

(TOUR button push) ➡ No 3 TOUR Execution of DOME

SPECIFICATIONS

Model	KBDPTZ1
Keyboard Communication	Interface: RS-485 (Tx 3 port, Trx 1 port) P
	an/Tilt operating distance :4700 ft (1029m) No 24 AWG wire
	Protocol: Multiple (Pelco-d, etc.) (Baud rate selectable)
Connector Type Data	TERMINAL BLOCK(8p)
Keyboard Keypad	Rubber button
	Numeric keypad and camera function key
Joystick	Stick 3-axis, variable speed with zoom
Input Voltage	12V DC or 9V batt (battery mode)
Power Consumption	Max.140mA
LCD Display	Graphic display : 16 * 2 Graphic display
Operating Temperature	0 to 45
Humidity	10% -70 % non-condensing
Dimension & Weight	280(W) x 174(D) x 92(H), Net : 0.7 Kg Gross: 1.7Kg
Packing include	WTX-1200A KEYBOARD, ADAPTOR
	Packing include : BATT 9V(Alkaline), USB CABLE, MANUAL, TERMINAL BLOCK(8p)

WARRANTY



LIMITED WARRANTY

THIS WARRANTY IS VALID ONLY ON PRODUCTS PURCHASED AND USED IN THE UNITED STATES OF AMERICA. THIS WARRANTY APPLIES ONLY TO THE ORIGINAL USER.

SUBJECT TO CONDITIONS AND EXCLUSIONS FOUND BELOW, THIS PRODUCT IS WARRANTED AGAINST MANUFACTURING DEFECTS IN MATERIAL AND WORKMANSHIP FOR THE FOLLOWING PERIOD FOR PARTS AND LABOR:

SPECO TECHNOLOGIES CAMERAS:	5 YEARS
SPECO TECHNOLOGIES MONITORS:	1 YEAR
BALANCE OF SPECO TECHNOLOGIES LINE:	1 YEAR*
* IR LEDs, Time lapse VCR Drum Assemblies & Heads:	90-DAYS

SPECO TECHNOLOGIES WILL REPAIR OR REPLACE (AT OUR DISCRETION) ANY PARTS FOUND TO BE DEFECTIVE FOR THE WARRANTY PERIOD SPECIFIED. WE WILL PROVIDE A REPLACEMENT FOR ANY DEFECTIVE PART.

CONDITIONS

- 1. YOU MUST OBTAIN A RETURN AUTHORIZATION NUMBER FOR ANY MERCHANDISE BEING RETURNED TO SPECO TECHNOLOGIES, WHETHER FOR RETURN/EXCHANGE OR REPAIR, WHETHER IN OR OUT OF WARRANTY.**
2. THIS WARRANTY WILL BE HONORED ONLY UPON PRESENTATION OF THE ORIGINAL DATED BILL OF SALE OR SALES SLIP.
3. TRANSPORTATION OF THE PRODUCT TO OUR SERVICE DEPARTMENT IS THE RESPONSIBILITY OF THE USER. REPAIRED OR REPLACED PRODUCT WILL BE RETURNED PREPAID DURING THE WARRANTY PERIOD.

EXCLUSIONS

1. THIS WARRANTY SHALL NOT COVER ADJUSTMENT OF CUSTOMER OPERATED CONTROLS AS EXPLAINED IN THE APPROPRIATE MODEL'S INSTRUCTION MANUAL OR PRODUCTS WHICH HAVE BEEN ALTERED, ABUSED, OR HAVE MISSING OR ALTERED SERIAL NUMBERS.
2. THIS WARRANTY SHALL NOT APPLY TO UNCRATING, SETUP, INSTALLATION, OR THE REMOVAL AND REINSTALLATION OF PRODUCTS AFTER REPAIR.
3. THIS WARRANTY SHALL NOT APPLY TO REPAIRS OR REPLACEMENTS NECESSITATED BY ANY CAUSE BEYOND THE RESULT OF MANUFACTURE INCLUDING, BUT NOT LIMITED TO, ANY MALFUNCTION, DEFECTS OR FAILURE CAUSED BY OR RESULTING FROM UNAUTHORIZED SERVICE OR PARTS, IMPROPER MAINTENANCE, MODIFICATION OR REPAIR BY THE USER, ABUSE, MISUSE, NEGLIGENCE, ACCIDENT, FIRE, FLOOD, OR OTHER ACTS OF NATURE, INCORRECT LINE VOLTAGE, DAMAGE OR IMAGE BURNS TO TELEVISION PICTURE TUBES CAUSED BY OR ATTRIBUTABLE TO THE USE OF ANY ACCESSORY, ELECTRONICS GAME OR DEVICE, OR DAMAGE CAUSED TO IMAGE PICKUP DEVICES BY EXCESSIVE LIGHT.

THE FOREGOING IS IN LIEU OF ALL OTHER EXPRESSED WARRANTIES AND WE DO NOT AUTHORIZE ANY PARTY TO ASSUME FOR US ANY OTHER OBLIGATION OR LIABILITY. IN NO EVENT SHALL WE BE LIABLE FOR INCIDENTAL OR CONSEQUENTIAL DAMAGES ARISING FROM THE USE OF THIS PRODUCT, OR FOR ANY DELAY IN THE USE OF THIS PRODUCT DUE TO CAUSES BEYOND OUR CONTROL.

SOME STATES DO NOT ALLOW LIMITATIONS OF HOW LONG AN IMPLIED WARRANTY LASTS AND/OR DO NOT ALLOW THE EXCLUSION OR LIMITATION OF CONSEQUENTIAL DAMAGES. THE ABOVE LIMITATIONS ON IMPLIED WARRANTY AND CONSEQUENTIAL DAMAGES MAY NOT APPLY TO YOU.

THIS WARRANTY GIVES YOU SPECIFIC LEGAL RIGHTS. YOU MAY HAVE OTHER RIGHTS WHICH VARY FROM STATE TO STATE.

NOTE: FOR YOUR PROTECTION IN THE EVENT OF THEFT OR LOSS OF THIS PRODUCT, PLEASE FILL IN THE INFORMATION REQUESTED BELOW AND RETAIN WITH YOUR SALES RECEIPT.

MODEL NO.: _____ SERIAL NO.: _____
(LOCATED ON BACK OR BOTTOM OF UNIT)

DATE OF PURCHASE: _____

WHERE PURCHASED: _____ PURCHASE PRICE: _____

Speco Technologies
200 NEW HIGHWAY
AMITYVILLE, NY 11701 www.specotech.com

FOR MORE INFORMATION REGARDING
SERVICE OR RETURN, CALL US
TOLL FREE: 1-800-645-5516 IN METRO NY: 631-957-8700

ALWAYS USE DISCRETION WHEN INSTALLING VIDEO AND/OR AUDIO SURVEILLANCE EQUIPMENT ESPECIALLY WHEN THERE IS AN EXPECTATION OF PRIVACY. INQUIRE REGARDING FEDERAL, STATE AND/OR LOCAL REGULATIONS APPLICABLE TO THE LAWFUL INSTALLATION OF VIDEO AND/OR AUDIO RECORDING OR SURVEILLANCE EQUIPMENT. PARTY CONSENT MAY BE REQUIRED.

☐ MEMO



**200 New Highway
Amityville, NY 11701
631-957-8700
www.specotech.com**

VER. 080827

This manual is based on the date as shown in the right and specifications are subject to Change without notice for quality improvement.