

SDC Security Door Controls

801 Avenida Acaso, Camarillo, Ca. 93041 • (805) 494-0622 • Fax: (805) 494-8861
 www.sdcsecurity.com • E-mail: service@sdsecurity.com



INSTALLATION INSTRUCTIONS E75 STANDALONE ELECTRONIC LOCKSET



UL US LISTED
 Electrically Operated Single Point Locks
 & Latches, 3hr 'A' Label Fire Doors

- Keypad Programmable
- 3,000 Users, 32 Temporary Users
- 4 to 6 digit PIN Codes
- Passage Mode Option
- 32 Access Groups, Schedules
- 32 Holidays
- 4 Authority Levels
- Keypad Tamper Lockout
- Mechanical Key Override
- Battery Powered (4AA)
- Blue Backlit Cast Metal Keys
- Weather & Vandal Resistant
- Retrofit existing Lock Door Prep
- Motorized SDC Cylindrical Lockset
- Heavy Duty ANSI Grade 1
- Vandal resistant Lever Handles
- Privacy Mode Option (E75KL & E75PL only)

IMPORTANT: It is highly recommended that installers first view the "E75 STANDALONE ELECTRONIC KEYPAD" video available online at <https://www.sdcsecurity.com/videos.htm>

1 Place provided E75 Template on inside of door to mark hole locations.

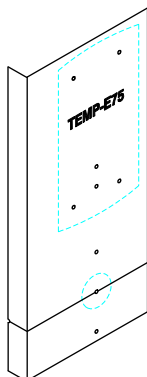

⇒ After marking hole locations, drill as follows;

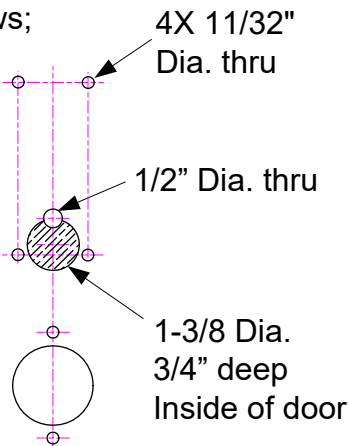

⇒ After drilling holes in door, use a 1/4" Butterfly bit, to drill the wire raceway where shown.

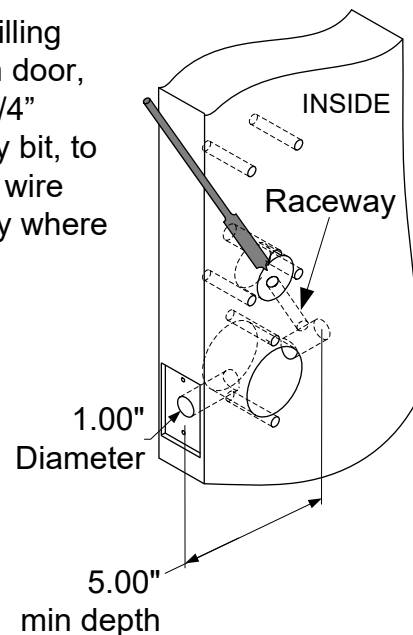

2 Pass a small pull wire through the raceway hole. This pull wire will be used to bring wires from the lockset hole to the keypad wiring area.

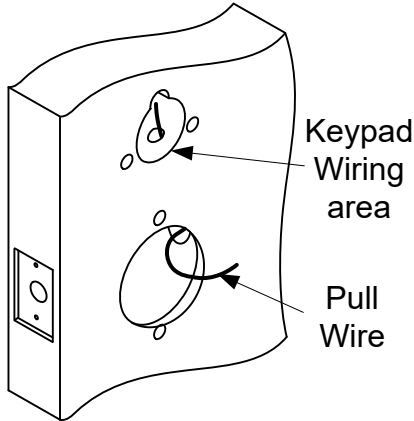

3 Install the Lockset. (Refer to lockset instructions)

4 Attach the Pull Wire to the Cylindrical Lock Wires. Pull the lock wires up through the raceway as you insert the cylindrical lock.

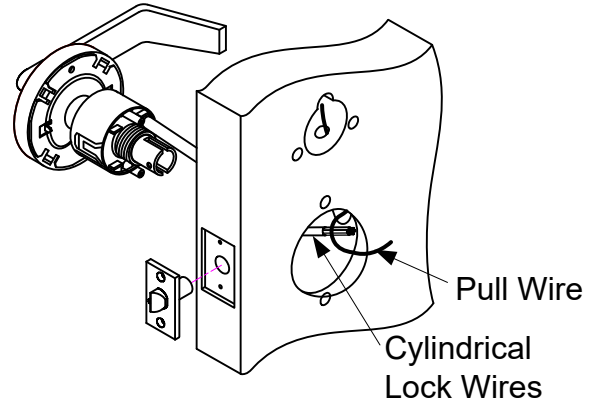

⇒ **FOR E75KL or E75PL Privacy Locks, skip to Steps 8-10 on the next page.**
For all other models, follow Steps 5-7 below.

5 Install the Keypad and Battery pack to the door

6 Attach wires from the lockset to the keypad using the chart to the right.

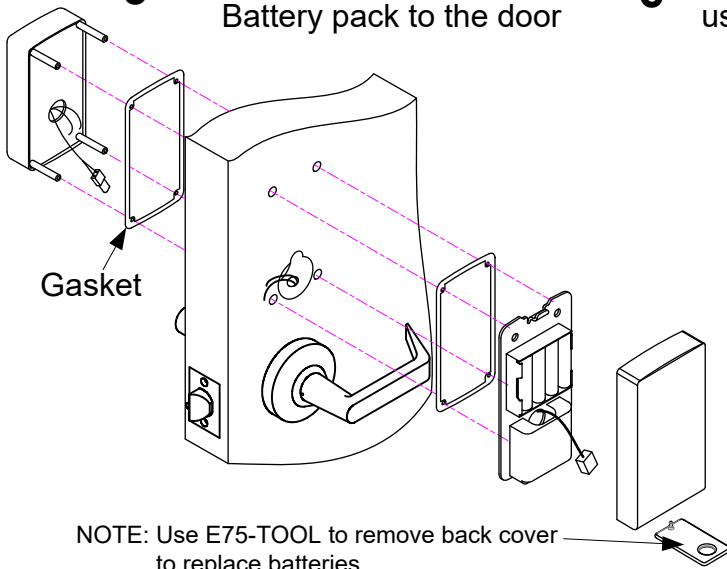

Function	From Keypad	From Lockset
Motor +	RED	RED
Output -	WHT	WHT

7 Apply power by plugging in the keypad's 2-wire connector to the battery pack connector. The left LED will flash rapidly as shown below followed by 3 beeps.



Replace the cover over the battery pack by first hooking the top and gently pressing the bottom

NOTE: Use E75-TOOL to remove back cover to replace batteries.

Specifications

Power	4AA Batteries (Alkaline only) or External 12VDC Power @ 30mA
Inputs	1 Request-To-Exit 1 Door Position Switch
Output	SPDT Contacts 1A @ 30VDC Relay
Temperature	-20° F to +130° F (-30° C to +54° C)
Humidity	5% to 95% non-condensing
Latch Bolt	9/16"
Backset	2-3/4"
Strike	4-7/8" ANSI A115.2
Door Thickness	1-3/4" to 2-1/8"

Additional Wire Connections (Optional)

Request-To-Exit Input	=	BLU(N/O) / BLK(COM)
Door Position Switch Input	=	GRY / BLK(COM)
Auxiliary Relay Output	=	ORG (N/C) WHT(COM) YEL(N/O)
System Reset	=	BRN / BRN
12VDC External Power (NOTE: Ext. pwr harness ships separately in box)	=	RED(+) / BLK(-) (22AWG)

Steps 8-10 for E75KL and E75PL Privacy models only,

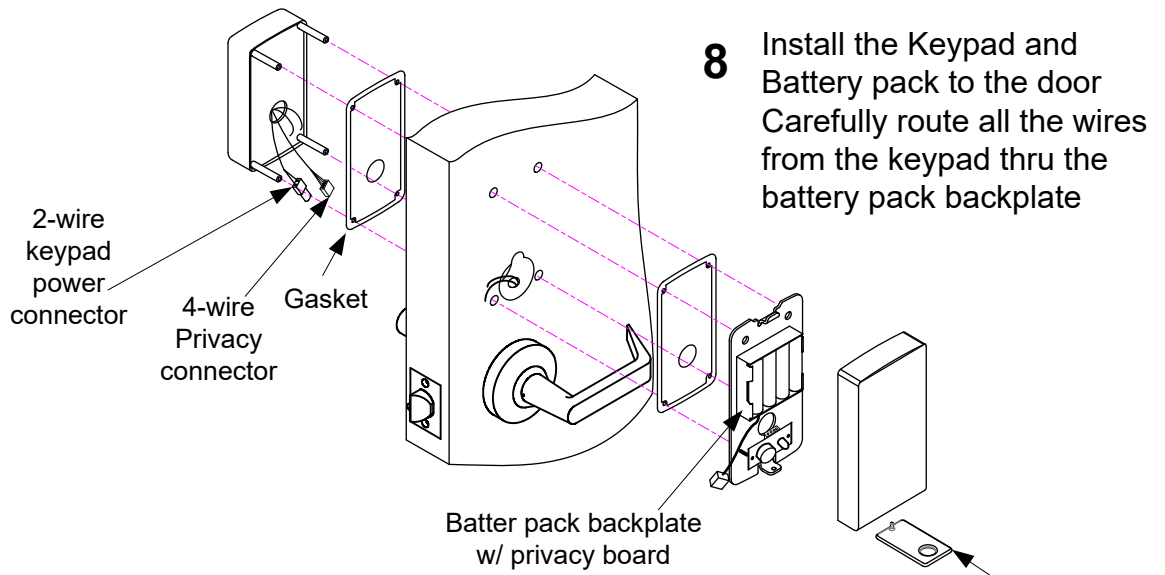

NOTE: Use E75-TOOL to remove back cover to replace batteries.

- 9** a. Connect the 4-wire privacy cable to the back of the privacy board.
 b. Attach wires from the lockset to the keypad using the charts below.

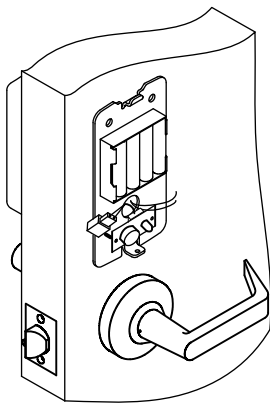

Function	From Keypad	From Lockset
Motor Output	+	RED
	-	WHT

Function	From Keypad	From Lockset
Privacy Reset	BLUE	WHT/RED
	BLACK	YEL/RED

- 10** Apply power by plugging in the keypad's 2-wire connector to the battery pack connector. The left LED will flash rapidly as shown below followed by 3 beeps.



Replace the cover over the battery pack by first hooking the top and gently pressing the bottom, ensuring that the privacy button and LED are properly aligned with the cover holes.

Additional Wire Connections from Keypad (Optional)

- Door Position Switch Input = GRY / BLK(COM)
- Auxiliary Relay Output = ORG (N/C)
WHT(COM)
YEL(N/O)
- Factory Reset = BRN / BRN
- 12VDC External Power = RED(+) / BLK(-) (22AWG)
(NOTE: Ext. pwr harness ships separately in box)

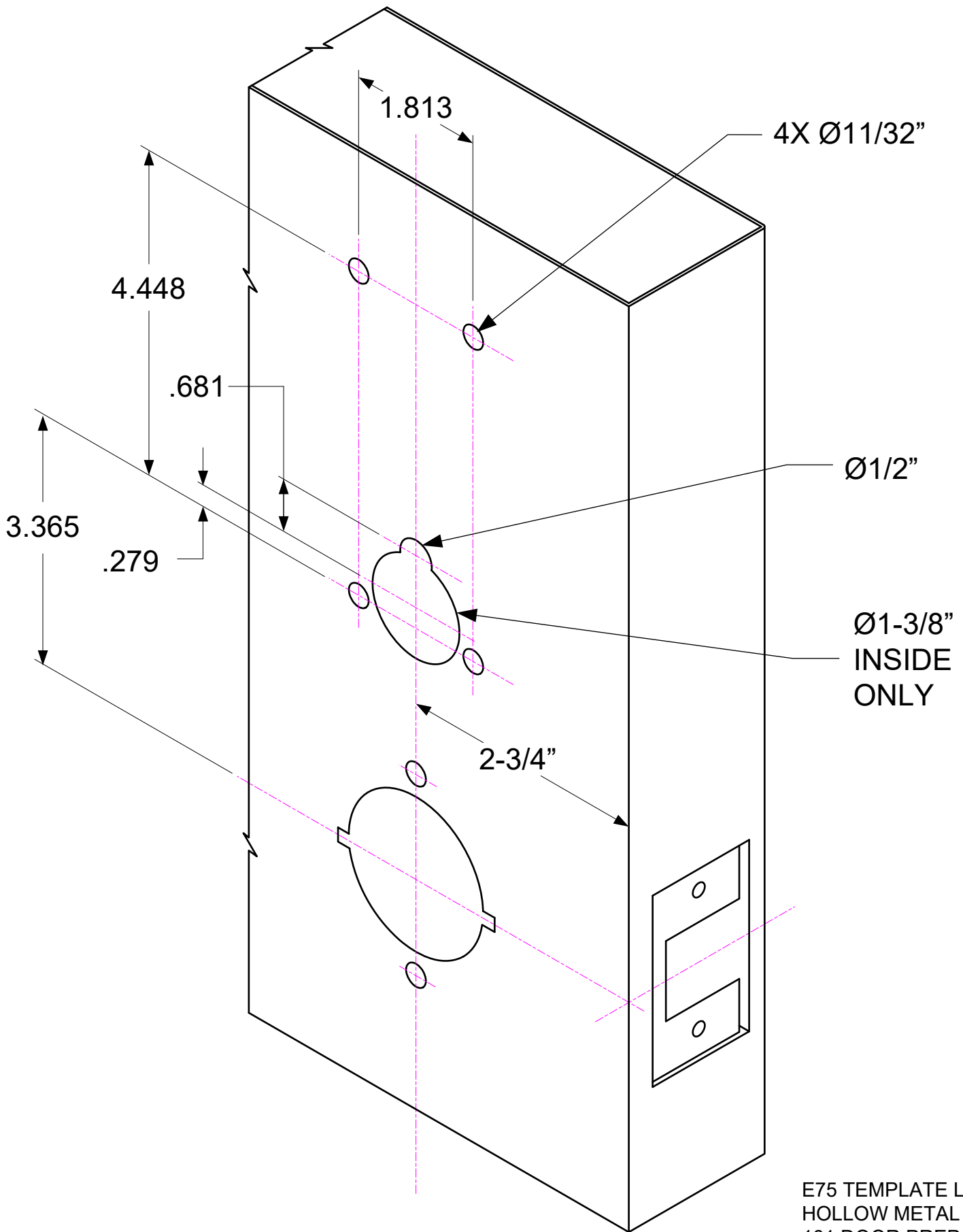

E75 TEMPLATE LAYOUT
 HOLLOW METAL DOOR
 161 DOOR PREP
 2-3/4" BACKSET

Quick Start Programming Instructions E75 EntryCheck™

For a complete list of lock programming functions, [including programming for the E75KL/E75PL Privacy Lock](#), refer to the E75 Programming Guide included with this lock.





Test the Lock Operation

To test lock operation before initialization, enter ***741**. This temporary code will unlock the E75 for testing purposes. Once a lock initialization has been performed, this code is no longer active until a hardware reset is performed which will erase all the users and return the E75 back into the uninitialized factory default condition.

Lock Initialization

When the lock is first installed or after a factory reset has been performed, the E75 must be initialized with a 4-digit lock ID before you will be allowed to enter programming mode.

To Initialize Lock:

Press #9* 123456# 0001#    

The above example enters a Lock ID of 0001. If multiple locks are used it is recommended that each lock have its own *Unique* Lock ID (0002, 0003, etc.). This is required when using the E7 Management Software.

User Programming

NOTE: You must first enter programming mode to perform any other function. 20 seconds of inactivity will automatically exit you from programming mode and return you to operational mode.

Enter Programming Mode:

Press #9# 01# 123456#      

User 01 with default PIN Code 123456 is the administrator and has full programming rights.

Add a User PIN Code (4-6 digits): 01# User No.# PIN Code # Pin Code # Group No.#

Example: Press 01#   04#   5050#   5050#   06#  

You have just added User #04 with a PIN of 5050 to unlock the door.

User 4 has been assigned to group 06 (24/7 access).

Add a Single Card: 06# User No.# Present Card

Example: Press 06#   04#   Present Card  

You have just added a card to User #4.

User 4 has also be assigned to group 06 (24/7 access).

**Prox Units
Only**

Add a Sequential Batch of Cards: 08# Starting User No.# No. of Cards# Present 1st Sequential Card

Example: Press 08#   05#   10#   Present Card  

You have just added (10) proximity card for User #'s 05 to 14.

All users has also be assigned to group 06 (24/7 access).

Exit Programming Mode: **#



Press **#      

Test the lock by pressing 5050#, or present a valid prox card to the reader (prox units only).

Additional E75 Programming

Refer to the E75 Programming Guide for a complete list of lock programming functions.

Change a User PIN Code: 03# User No.# New PIN Code # New Pin Code

Example 1: Press 03#   01#   123123#   123123#    

You have just changed the Administrator's Pin Code to 123123

NOTE: The Administrator's PIN code must be 6 digits in length. All other PIN codes may be 4-6 digits in length

Example 2: Press 03#   04#   1220#   1220#    





You have just changed User #04's Pin code to 1220

Delete a User: 02# User No.#





Example: Press 02#   04#    

You have just Deleted User #04





Set Entry Mode : 05# Mode

Example 1: Press 05#   1#  

Unlock the door either by entering a (PIN + #) or presenting card.

Example 2: Press 05#   2#  

Unlock the door by presenting a valid card.

Example 3: Press 05#   3#  

Unlock the door by presenting card plus the associated user code (PIN + #).

Mode = 1 PIN or Card (default) 2 Card Only 3 Card AND Pin
--







Set Unlock Timer: 21# Seconds#

Example: Press 21#   03 #    

Seconds = 03-20

Unlock timer is set for 03 seconds. (default)

Beep on Key Press : 62# Status

Example 1: Press 62#   1#    

Status = 0 Disabled

The E75 will beep each time you press a key.

1 Enabled (default)

Set the Date: 30# MMDDYY#

Example: Press 30#   011513 #    

The date is set for January 15 th 2013

MM = 2 digit Month

DD = 2 digit Day

YY = 2 digit Year

Set the Time: 31# HH MM#

Example: Press 31#   1320 #    

The time is now set to 1:20 PM.

HH = Hours (24hr format)

MM = Minutes (24hr format)

Clear all Programming : 99# 000000

Example 1: Press 99#   000000 #    

All user codes are erased and settings are set to factory defaults. The Administrator Pin Code and Lock ID are not cleared.

Resetting the E75 to Factory Settings

Warning!! This procedure will preform a hardware reset and will erase all the users and custom settings returning the E75 back into the uninitialized factory default condition.

- 1) Remove power (Unplug the battery pack)
- 2) Short and hold the 2 Brown Reset wires together
- 3) Apply power. (Plug in the battery pack)



The left LED will light RED for a few seconds, followed by a flashing RED/GRN. When initialization is complete, you will hear 3 beeps.

- 4) Disconnect and insulate the Brown Reset wires.
- 5) Return to Page 4 of these instructions to initialize the lock.