

**USERS
MANUAL**

**TFT LCD MONITOR
MODEL: TME17A/TME19A**

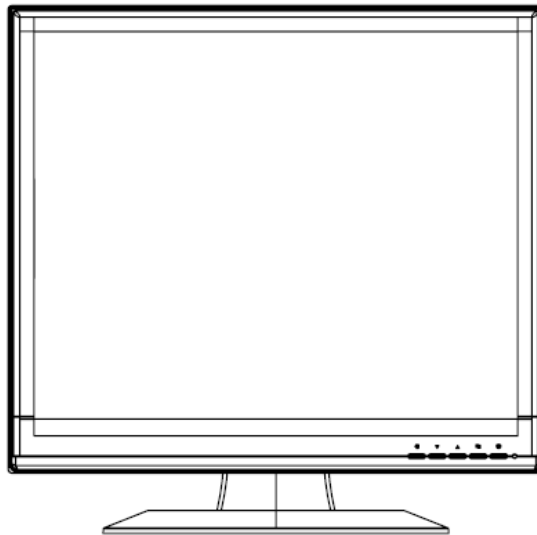

www.tatungusa.com

TABLE OF CONTENTS

● FCC information -----	1
● CE information -----	1
● Safety Precautions -----	1
1. Scope -----	3
2. Functional specification -----	3
3. Controls and indicators -----	5
4. OSD Menu -----	6
5. Regulatory Agency -----	19
6. Mechanical -----	20
7. Troubleshoot-----	22

FCC INFORMATION

This equipment has been tested and found to comply with the limits for a class B digital device, pursuant to Part 15 of the FCC Rules. These limits are designed to provide reasonable protection against harmful interference in a residential installation. This equipment generates uses and can radiate radio frequency energy and, if not installed and used in accordance with the instructions, may cause harmful interference to radio communications.

However, there is no guarantee that interference will not occur in a particular installation. If this equipment does cause harmful interference to radio or television reception, which can be determined by turning the equipment off and on, the user is encouraged to try to correct the interference by one or more of the following measures:

Reorient or relocate the receiving antenna.

Increase the separation between the equipment and receiver.

Connect the equipment into an outlet on a circuit different from that to which the receiver is connected.

- Consult the dealer or an experienced radio/TV technician for help.

Shielded interface cables and A.C. power cord, if any, must be used in order to comply with emission limits.

Changes or modifications not expressly approved by the party responsible for compliance could void the user's authority to operate the equipment.

CE INFORMATION

The product must be installed according to the currently valid installation regulations for EMC to guarantee the designed use and to prevent EMC problems.

The device supplied with this manual is according to the EC, EMC Directive, 2004/108/EC & LVD 2006/95/EC

SAFETY PRECAUTIONS

1. Do not modify the three-prong grounding type monitor power plug in any way.
2. Operate this unit only from the type of power source indicated on the label.
3. Do not block or cover ventilation openings on the back or bottom of the monitor cabinet.
4. Do not place this monitor near a radiator or heating vent.
5. Do not push objects of any kind through cabinet openings. This may result in fire or electrical shock.
6. Before adding attachments always ask a service technician to perform routine safety tests to determine that equipment is in safe operating condition. Ground potential tests should be part of the routine safety check made by the service technician.

7. Do not place monitor on an unstable cart, stand, or shelf where it may fall and injure personnel or damage equipment.
8. Route power cords so that they cannot be walked upon or tripped over. Do not allow anything to rest on the power cord.
9. Do not install monitor in wet areas, or where it may be exposed to rain or water. Do not spill liquid of any kind on the unit.
10. Unplug the power cord from the unit before cleaning the display. Use only a damp cloth. Do not use alcohol, spirits, or ammonia to clean the display. **DO NOT ATTEMPT TO CLEAN THE INTERIOR OF THIS UNIT- THIS ACTION MUST BE PERFORMED BY THE SERVICE TECHNICIAN AS REQUIRED DURING NORMAL MAINTENANCE.**
11. Refer all servicing to qualified service personnel. **REMOVAL OF BACK COVER BY UNAUTHORIZED PERSONNEL MAY EXPOSE THE USER TO DANGEROUS VOLTAGES OR OTHER HAZARDS.**
12. Unplug the unit immediately and notify the service technician.
 - A. If liquid has been spilled into the display or the display has been exposed to rain or water.
 - B. If the unit has been dropped or the cabinet damaged.
 - C. If fuses continue to blow.
 - D. If the power cord is damaged or frayed.
 - E. If a distinct change from normal operation is apparent.

When replacement parts are required, be sure that the service technician uses components specified by the manufacturer which have the same characteristics as the original parts. **UNAUTHORIZED SUBSTITUTIONS MAY RESULT IN FIRE, ELECTRICAL SHOCK OR OTHER HAZARDS.**

Upon completion of any service or repairs, ask the technician to perform safety checks to determine that the equipment is in safe operating condition.

WARNING: SERIOUS SHOCK HAZARDS EXIST WITHIN THE COVERS OF THIS MONITOR. DO NOT OPEN THE COVERS UNDER ANY CIRCUMSTANCES, THERE ARE NO USER SERVICEABLE COMPONENTS INSIDE

1. Scope

This specification is used to define the performance of TME17A / TME19A color TFT LCD monitor. This system also supports both video input and PC input. In video input mode, the system can automatically detect the NTSC signal and PAL signal. In PC mode, this system can support up to 1920 x 1080 VESA standard. The user friendly OSD menu is also provided to make this system easy to operate.

2 Functional Specifications

2.1 Power Supply

The power supply spec is listed below,

AC INPUT

AC power input range : Rated voltage 100 – 240 Vac +/- 10%, 47~63Hz,
2 Amps max.

* Power consumption : 35W max.

* Power efficiency : 80% typical at normal line input and full load

2.2 Video Characteristics

Composite Video (CVBS): 1.0 Vp-p (0.5 – 1.5Vpp), Automatic switching from 75 Ω unbalanced termination to Hi-Z with loop-through operation.

Y/C (S-video): 1.0 Vp-p (0.5 – 1.5Vpp), Automatic switching from 75 Ω unbalanced termination to Hi-Z with loop-through operation.

2.3 PC Input

● VGA Input

Analog RGB: 0.707 Vp-p.

Support VESA Standard Timing

● HDMI Input

HDMI Compatible Interface

Digital Signal: TMDS.

HDCP: HDCP 1.1

2.4 Audio Input

Signal Level: 1.0 Vrms

2.5 Environmental

- **Temperature**

Operating: 0°C to +40°C; 32°F to 104°F

Storage: -20°C to +60°C; -4°F to 140°F

- **Humidity**

Operating: 10% to 85% (non-condensing)

Storage: 10% to 95% (non-condensing)

2.6 EDID

This series of displays support EDID, but does not support DDC2B function.

2.7 Connectors

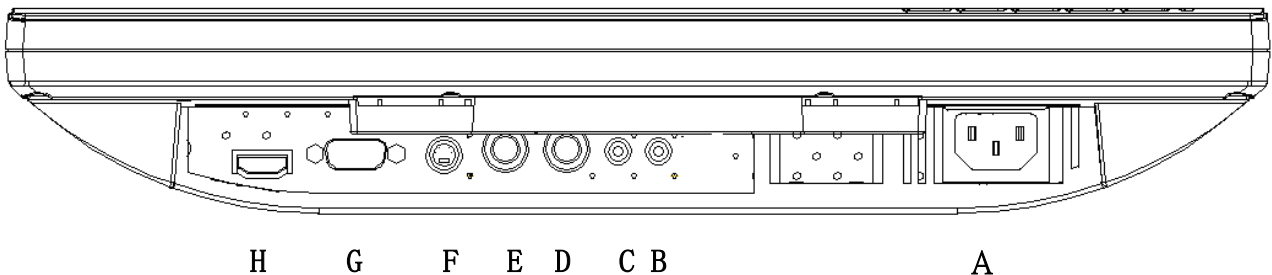

A. AC INPUT: AC SOCKET

B. AUDIO OUTPUT: Phone Jack, Stereo

C. AUDIO INPUT: Phone Jack, Stereo

D. CVBS OUTPUT: BNC Connector

E. CVBS INPUT: BNC Connector

F. S-VIDEO (Y/C) INPUT: Mini-DIN 4 pins Connector

G. VGA INPUT: D-SUB 15 pins Connector

H. HDMI INPUT: HDMI Connector

Set up sequence

1. Make sure the power of PC and/or Video source were turned off.
 2. Plug the Video signal and VGA cable to monitor.
 3. Turns the PC and/or Video source power on.
 4. Plug the AC power cord onto AC Socket.
- (Use reverse sequence to teardown the monitor).

3. Controls and indicators

TME17A/TME19A MONITOR

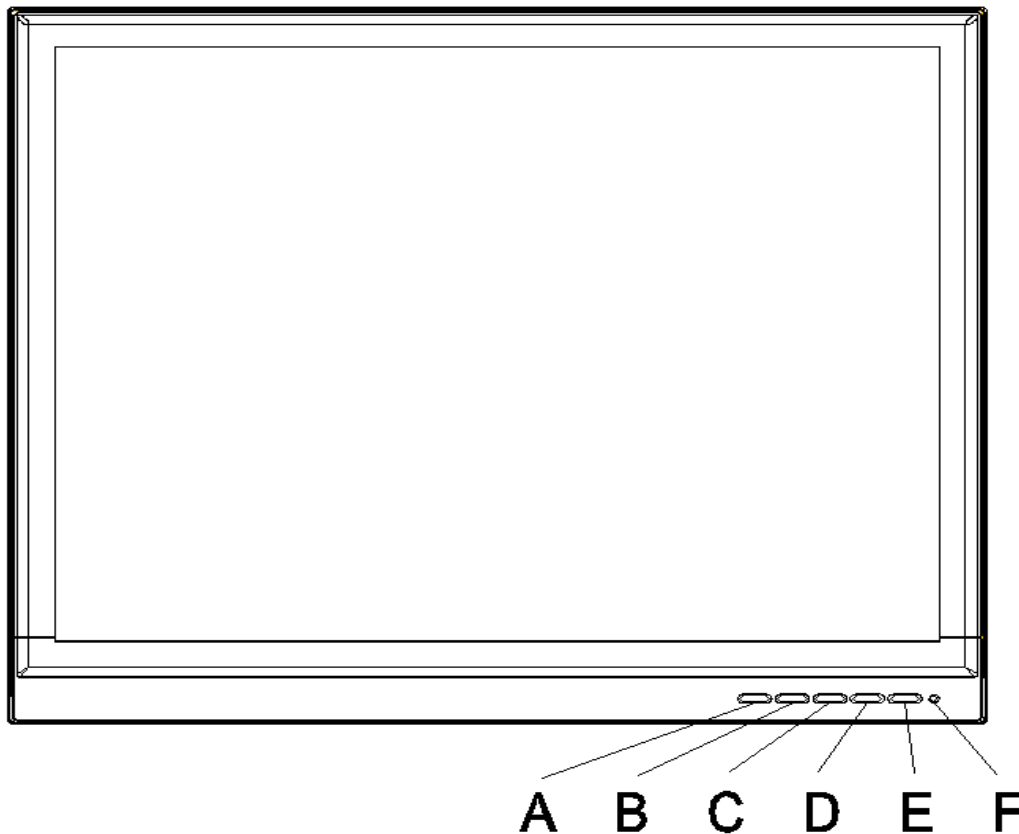

A. “” **Source button**

- Press the button to show source menu. Select HDMI, S-Video, VGA and VIDEO input signal

B. “” **Down buttons**

- Press the buttons to scrolling the cursor to desired function.
- Press the buttons to decrease the value of selected function in sub OSD menu.

C. “” **Up button**

- Press the buttons to scrolling the cursor to desired function.
- Press the buttons to increase the value of selected function in sub OSD menu.

D. “”Menu button

- Press the button to show the OSD main menu.
- As a confirmation key during the OSD operation.

E. “” Power button

Press the button to turn ON or turn OFF the monitor

F. POWER LED Indication

- Green - Power on
- LED light off - Power off
- Flash Green - Sleep mode (PC mode only)



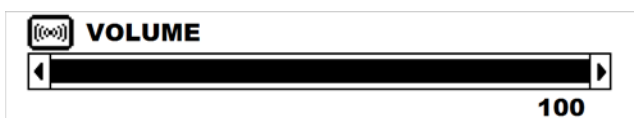

4. OSD Menu

Hot key :

Quick adjust keys from front panel hot keys :



VOLUME :

Press  or  button to select the function and press  /  buttons to adjust the volume , the press MENU button to exit OSD menu.



KEY LOCK : Push MENU key for 6 sec to enable this function.



KEY UN-LOCK : Push MENU key for 6 sec to disable this function.



RUNNING HOURS :

Remove AC power-> Push "  " & "  " key and Plug in AC power
->Display Running Hours information.

RUNNING HOURS: 0

VGA & HDMI mode :

OSD Menu structure :

Use the Source button to select the VGA, HDMI, CVBS, or S-VIDEO, the menu structure within each varies, refer to sections below on how to set-up each option.

VGA / HDMI mode :

Press the Menu button to bring up the MAIN MENU Page. The following page will appear
Press UP / Down buttons to select an icon, then Press MENU button to change the values in the sub menu.

VGA MAIN MENU

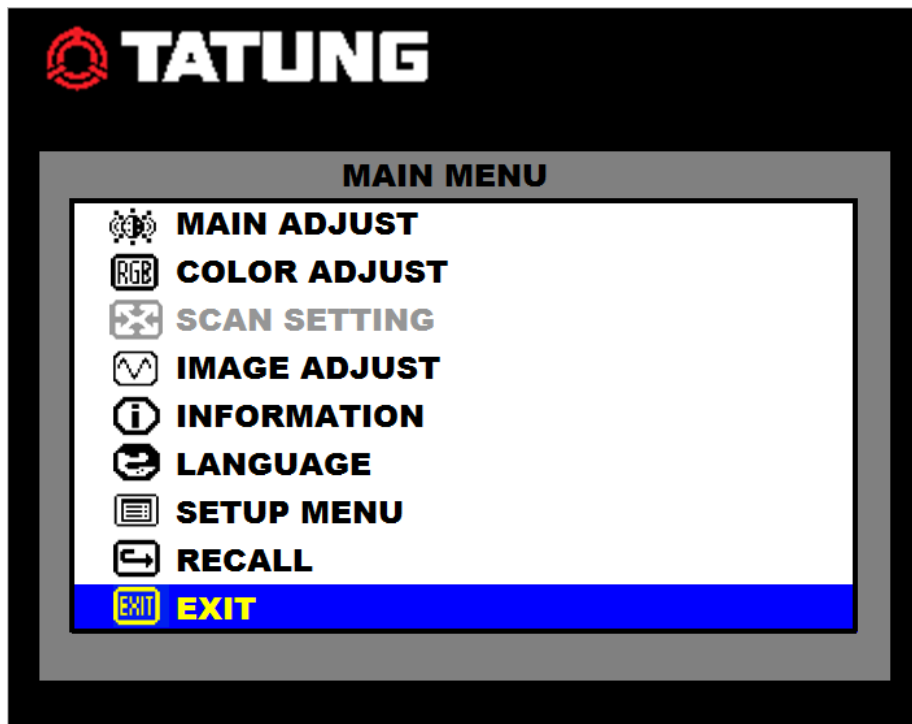

HDMI MAIN MENU

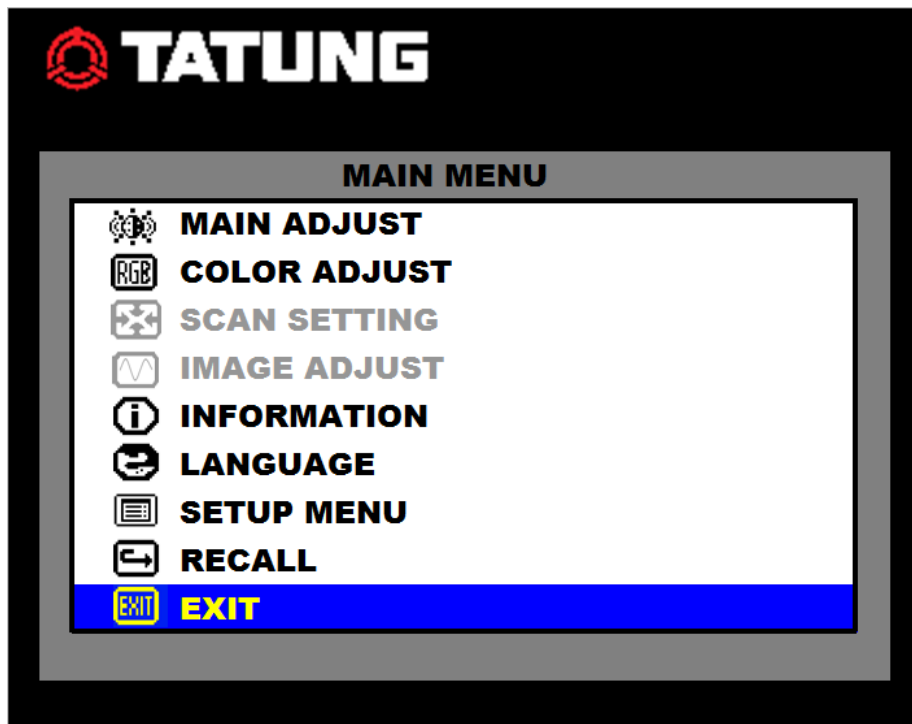

MAIN ADJUST :

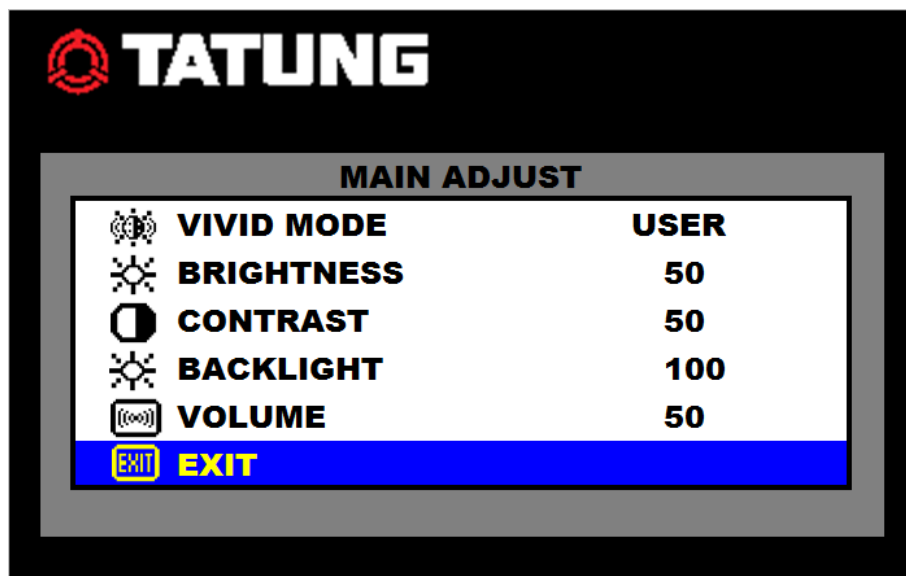

1. Press Down / UP buttons to select an icon.
2. Press MENU button to select item,
3. Press Down / UP buttons to adjust the value
4. Press MENU button to return



VIVID MODE : Select the VIVID MODE (0~3 and USER)
 USER, 0: TEXT, 1: PHOTO, 2: MOVIE, 3: GAME



BRIGHTNESS : Adjust the brightness value



CONTRAST : Adjust the contrast value



BACKLIGHT : Adjust the backlight value



VOLUME : Adjust the volume



EXIT : Press MENU button to return to the main menu



COLOR ADJUST :

Set the color temperature of the LCD monitor for the CIE coordinate 9300°k or 6500°k or USERMODE

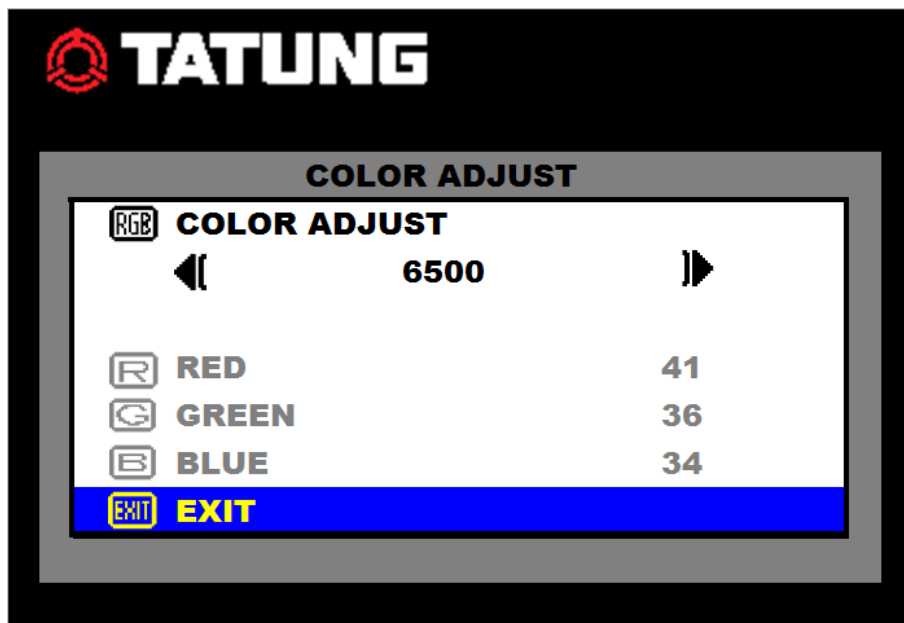

1. Press Down / UP buttons to select an icon
2. Press MENU button to select adjust item,
3. Press Down / UP buttons to adjust the value
4. Press MENU button to return

USER COLOR : Adjust the color temperature.

 **RED** : Adjust the RED value for user mode.

 **GREEN** : Adjust the GREEN value for user mode.

 **BLUE** : Adjust the BLUE value for user mode.

 **EXIT** : Press MENU button to return to the main menu.

 **IMAGE ADJUST (VGA ONLY)** :

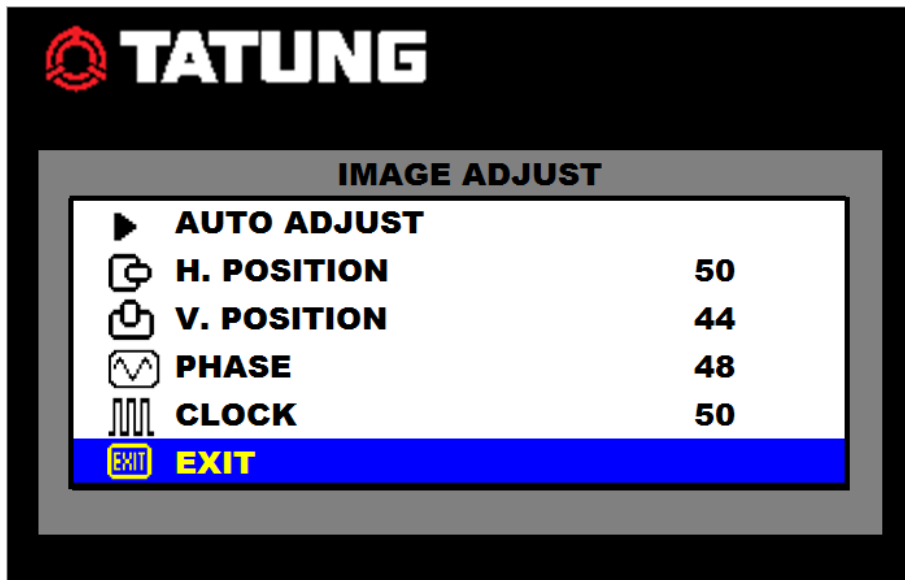

1. Press Down / UP buttons to select an icon
2. Press MENU button to select adjust item
3. Press Down / UP buttons to adjust the value
4. Press MENU button to return.

 **AUTO ADJUST** : Press MENU buttons to auto adjust the H. Position, V. Position, Phase, Clock

 **H. POSITION** : Adjust the horizontal position value

 **V. POSITION** : Adjust the vertical position value

 **PHASE** : Adjust the phase value



CLOCK : Adjust the clock value



EXIT : Press MENU button to return to the main menu



INFORMATION :

Press MENU button to get the VGA timing information

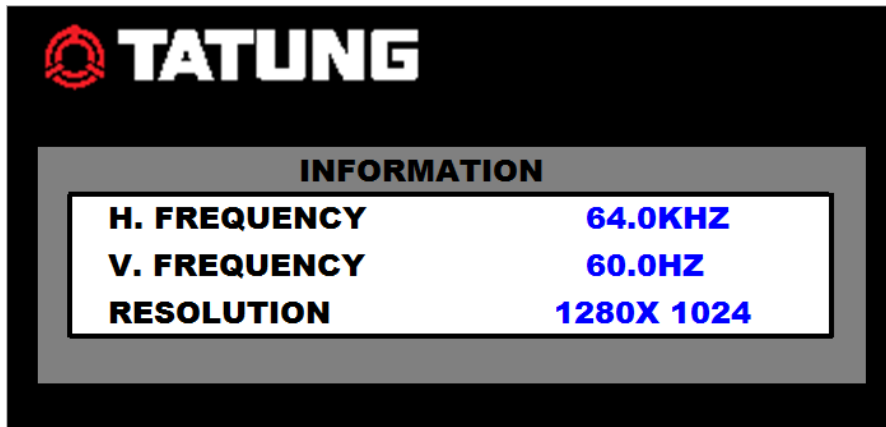

LANGUAGE : Press MENU button to enter the sub-menu



1. Press Down / UP buttons to select language
2. Press MENU button to enter



SETUP MENU :

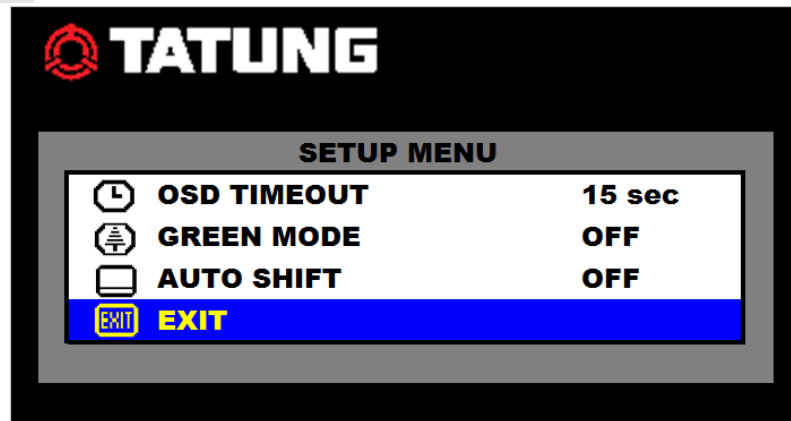

1. Press Down / UP buttons to select an icon
2. Press MENU button to select adjust item
3. Press Down / UP buttons to adjust the value
4. Press MENU button to return



OSD TIMEOUT : Adjust the OSD Show time (5 ~120 sec)



GREEN MODE : Off or On (5 min~10 min)

OFF – No function

ON – Screen will reduce back light to 80% within (5 min to 10 min)

Screen will back to normal when any button is being touched.



AUTO SHIFT : Adjust AUTO SHIFT ON/OFF

OFF – No Function

ON – Every one hour there will one scan line from top to bottom (Every 1 second down one scan line) to prevent panel sticking.

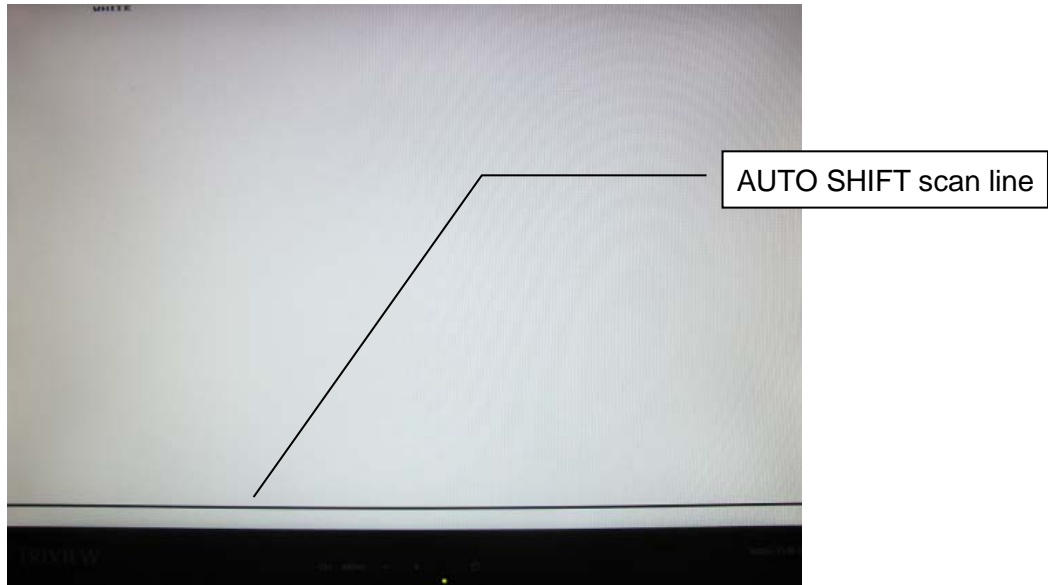

EXIT EXIT : Press MENU button to return to the main menu

RECALL :

Brightness, Contrast, Volume, Vivid Mode, OSD Timeout, Green Mode, Auto Shift return to default Value.

Video mode :

Press the Menu button to bring up the MAIN MENU Page. The following page will appear Press Down / UP buttons to select an icon, then Press MENU button to change the values in the sub menu.

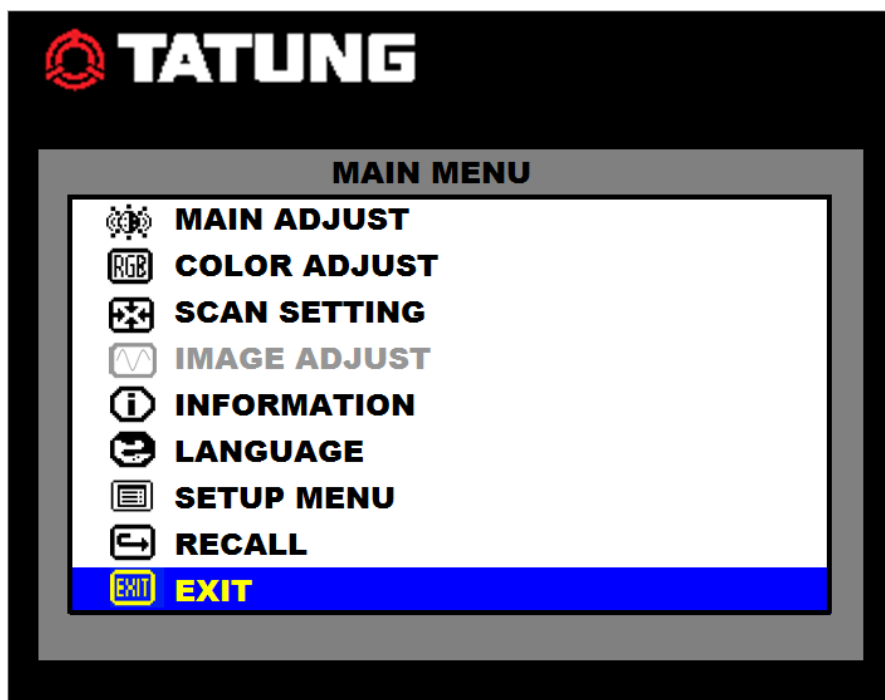



MAIN ADJUST :

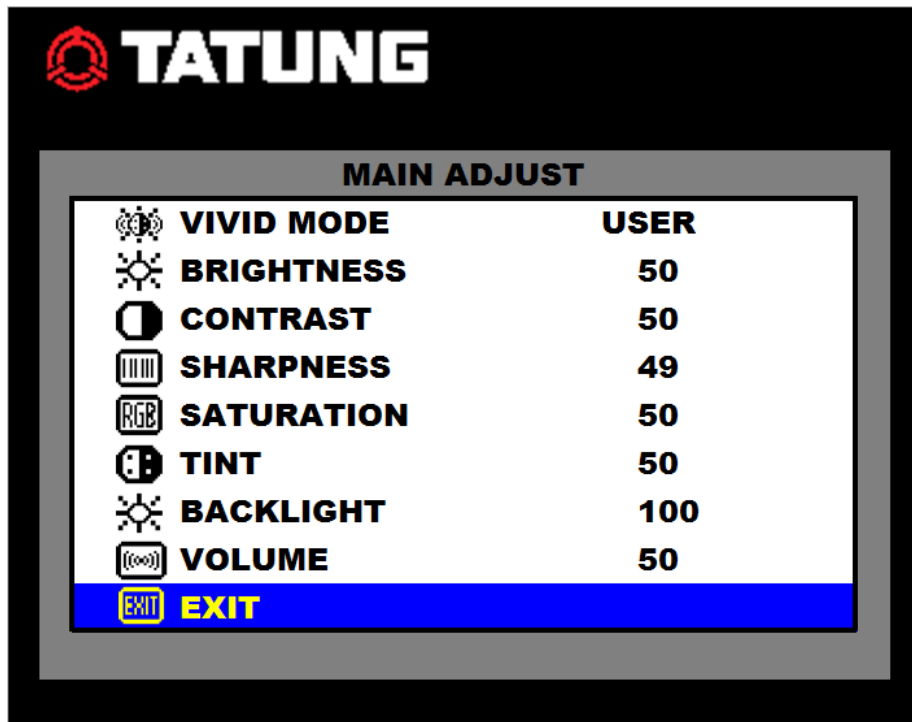

1. Press Down / UP buttons to select an icon.
2. Press MENU button to select item.
3. Press Down / UP buttons to adjust the value
4. Press MENU button to return.



VIVID MODE : Select the VIVID MODE (0~3 and USER)
 USER, 0: TEXT, 1: PHOTO, 2: MOVIE, 3: GAME



BRIGHTNESS : Adjust the brightness value.



CONTRAST : Adjust the contrast value.



SHARPNESS : Adjust Image sharp.



SATURATION : Adjust Image saturation.



TINT : adjust Image tint. (NTSC only).



BACKLIGHT : Adjust the backlight value



VOLUME : Adjust the volume .

EXIT EXIT : Press MENU button to return to the main menu.

RGB COLOR ADJUST :

Set the color temperature of the LCD.
monitor for the CIE coordinate 9300°k or 6500°k or USER MODE.

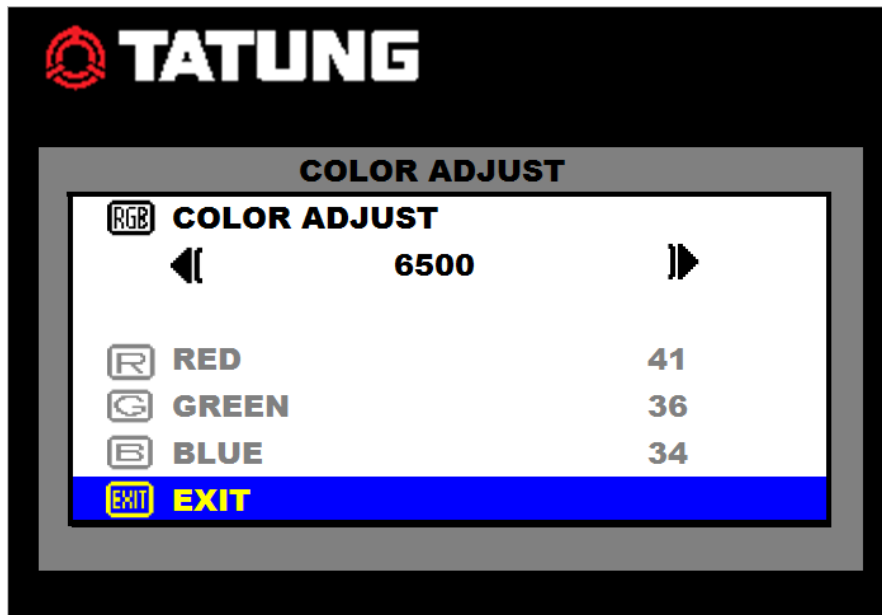

1. Press Down / UP buttons to select an icon.
2. Press MENU button to select adjust item,
3. Press Down / UP buttons to adjust the value..
4. Press MENU button to return.

USER COLOR : Adjust the color temperature.

R RED : Adjust the RED value for user mode.

G GREEN : Adjust the GREEN value for user mode.

B BLUE : Adjust the BLUE value for user mode.

EXIT EXIT : Press MENU button to return to the main menu.



SCAN SETTING :

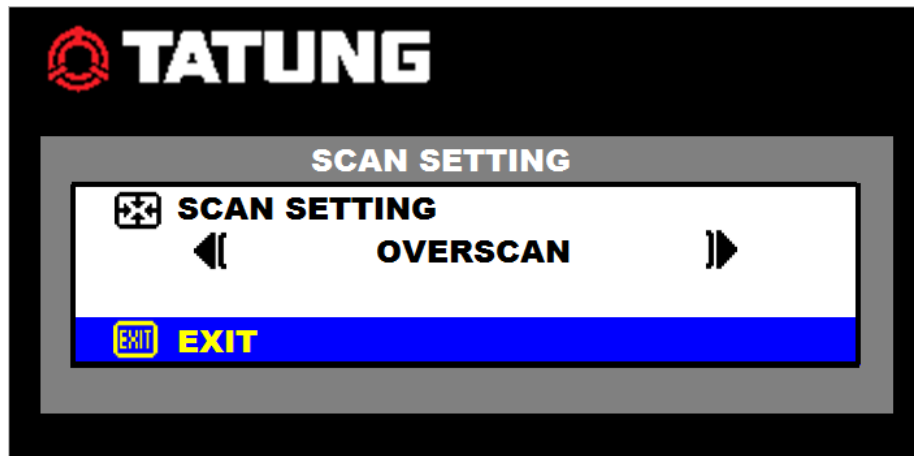

1. Press MENU button to select the sub-menu.
2. Press Down / UP buttons to select Scan Setting state.
3. Press MENU button to return.



INFORMATION :

Press MENU button to get the timing information.

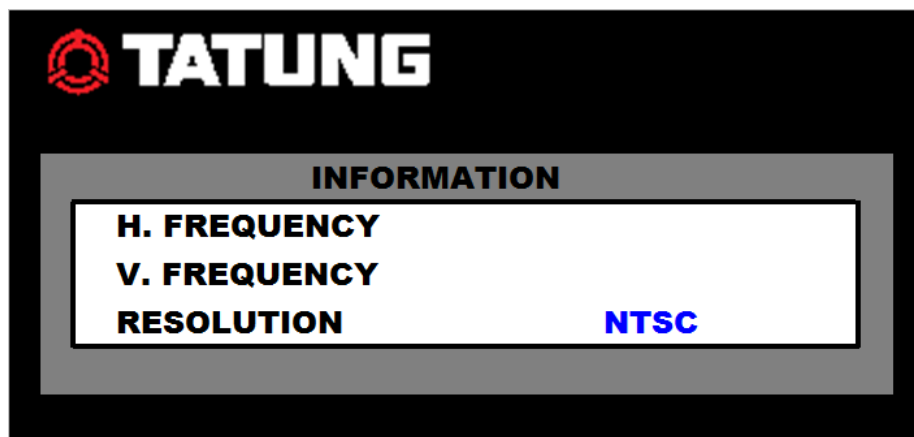



LANGUAGE : Press MENU button to enter the sub-menu.



1. Press Down / UP buttons to select language.
2. Press MENU button to enter.



SETUP MENU :

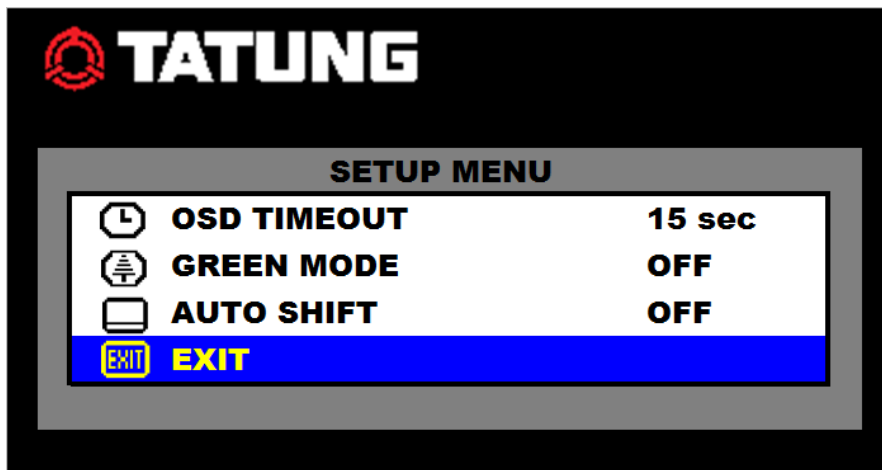

1. Press Down / UP buttons to select an icon.
2. Press MENU button to select adjust item.
3. Press Down / UP buttons to adjust the value.
4. Press MENU button to return.



OSD TIMEOUT : Adjust the OSD Show time (5 ~120 sec).



GREEN MODE : Off or On (5 min~10 min).

OFF – No function.

ON – Screen will reduce back light to within (5 min to 10 min).

Screen will back to normal when any button is being touched.



AUTO SHIFT : Adjust AUTO SHIFT ON/OFF.

OFF – No Function.

ON – Every one hour there will one scan line from top to bottom.

(Every 1 second down one scan line) to prevent panel sticking.

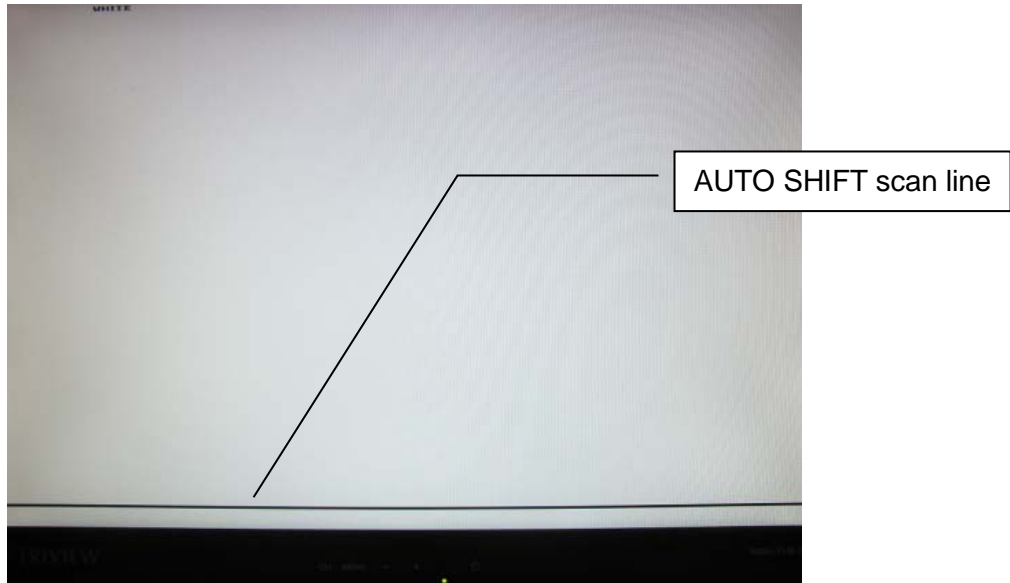

EXIT : Press MENU button to return to the main menu.



RECALL :

Brightness, Contrast, Sharpness, Saturation, Tint, Volume, Vivid Mode, OSD
Timeout, Green Mode, Auto Shift return to default Value.

5. Regulatory Agency

5.1 Safety Approvals

This series design shall meet the standards of the following domestic and foreign agencies:

CE LVD : EN60950-1

5.2 EMI/EMS Emission Approvals.

This series design shall meet following EMI/EMS specifications:

FCC Compliance: FCC Rules and Regulations, Part 15, subpart B, Class B.

CE COMPLIANCE: EN55032 class B, EN55024, EN50130-4.

6. Mechanical

6.1 Cabinet

Material: Plastic

Finish: Black

6.2 Dimensions (Physical)

Unit: inch

TME17A

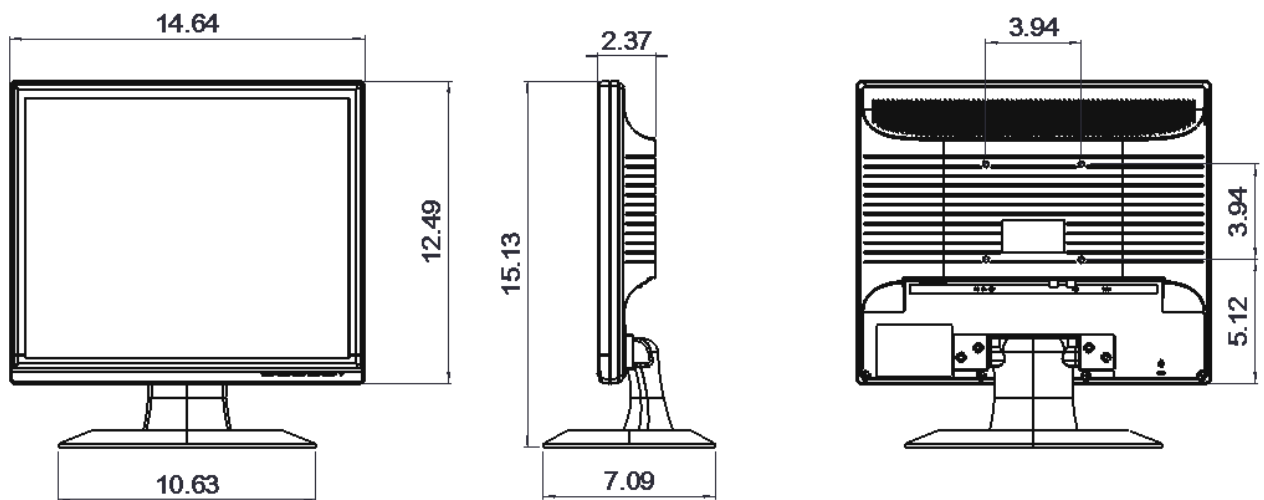

TME19A

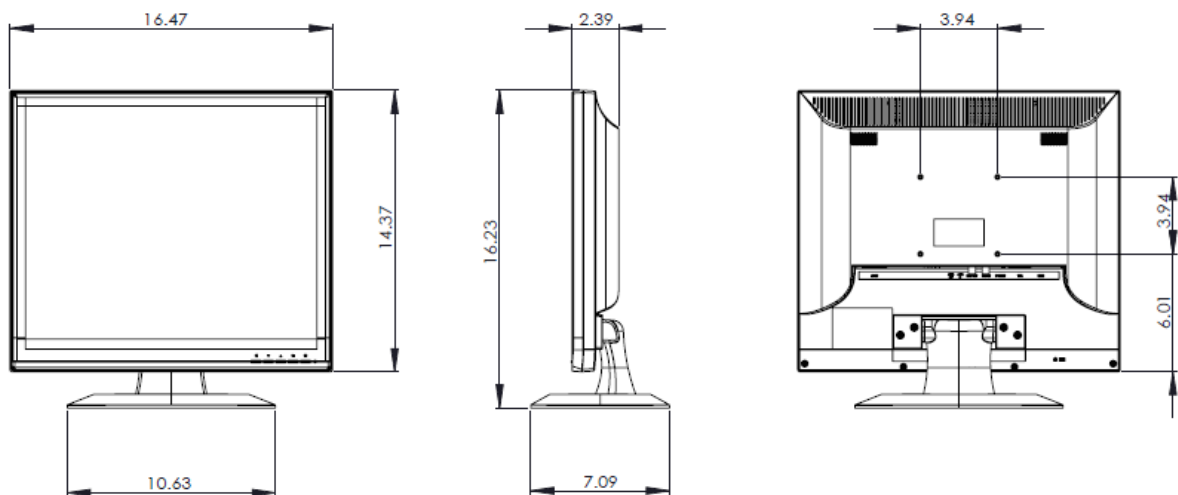

- Weight:

Model	kgs	lbs
TME17A	2.9	6.39
TME19A	3.6	7.94

6.3 Dimension (Packing):

- Size

Model	Unit	W	L	H
TME17A	mm	450	138	467
	Inch	17.72	5.43	18.39
TME19A	mm	464	121	585
	Inch	18.27	4.76	23.03

- Weight:

Model	kgs	lbs
TME17A	3.71	8.18
TME19A	4.44	9.79

7. Troubleshoot

- **Item 1 LED indicator is off**

- Check if power cord is plugged into the AC socket.
- Check if the LCD Monitor is turn on.

- **Item 2 No picture**

- Check if the Video cable plugged into the device well.
- Check if the computer is in standby mode or power on.

- **Item 3 No Audio output**

- Check if the audio cable plugged into the device well.
- Check if the volume is set to 0.
- Check if AUDIO is set to mute.

If you are experiencing trouble with your product, try the following solutions. You may contact Tatung's service department if the problem persist at 1-800-829-2850 ext 216 or email service@tatungusa.com

**TATUNG COMPANY OF AMERICA, INC.
LIMITED WARRANTY
COMMERCIAL DISPLAY MONITOR PRODUCT**

**TATUNG COMPANY OF AMERICA, INC.
LIMITED WARRANTY COMMERCIAL DISPLAY MONITOR PRODUCT**

Tatung Company of America, Inc. (“Tatung”) warrants to you, the original commercial purchaser of this new Tatung product (the “product”), that all parts of this product will be free from defects in materials or workmanship, as hereinafter provided, for three years from the date of original purchase.

Tatung will, at our option, repair or replace the product or any part thereof which becomes defective, malfunctions or otherwise fails to conform with this warranty under normal use and service during the term of this warranty, at no charge to you for parts and labor. Repaired or replacement products or parts may include remanufactured or refurbished parts and components. The repaired or replacement product will be covered for the balance of the time remaining on the product's original limited warranty period.

You may obtain warranty service by contacting Tatung Customer Support at (800) 827-2850, Ext. 242, to obtain a Return Merchandise Authorization number (RMA). You will be required to provide:

- A copy of the dated sales receipt from Tatung (Proof of Purchase).
- Your Name or Company Name
- The model number and serial number of the product
- A description of the problem
- Your ship-to address, email address, fax number and phone number

Upon receipt of the RMA, you can bring or ship the product at your expense to the address provided with the RMA. Please make sure that the product is packed in a suitable carton that is large enough and strong enough to allow you to properly secure the product. Tatung will not be responsible for any loss or damages as a result of shipping in the product for service, and shipping insurance is recommended to protect you against any loss or damages resulting from shipping.

TATUNG SHALL NOT BE LIABLE FOR ANY LOSS OR DESTRUCTION OF, OR TO MAINTAIN THE CONFIDENTIALITY OF, DATA, MEDIA OR ANY CONTENT COMPONENT, SUCH AS PHOTOS, FEEDS, TEMPLATES, ETC., RESULTING FROM WARRANTY SERVICE OF THE PRODUCT. IT IS YOUR RESPONSIBILITY TO SECURE AND/OR BACK-UP ALL PROGRAMS AND DATA CONTAINED IN OR AFFECTED BY THE PRODUCT.

This warranty does not cover:

1. Defects, malfunction or failures resulting from causes beyond the control of Tatung or the manufacturer of the product, including, but not limited to, shipping or transit accident, abuse, misuse, operation contrary to furnished instructions, improper or insufficient ventilation, operations with incorrect power supplies, operation with faulty associated equipment, modification, alteration, improper servicing, accidents, fire, power surges, viruses, malware, acts of God, tampering, reckless, willful or intentional conduct, or normal wear and tear;
2. Cosmetic damage, such as scratches, plastic discoloration, etc., to the exterior finish during the warranty period;
3. Burned-in images (screen burn) resulting from viewing of images on the display screen for an extended period of time;
4. Display problems or reception interference and distortion related to echo, interference, noise or other signal transmission and delivery/reception problems;
5. Minor display imperfections within the product's design specifications that do not materially alter functionality;
6. Any reimbursement cost for removal, installation and set-up, including wall-mounting of product;
7. Products on which the serial number has been altered, defaced or removed; and
8. Products purchased outside of the United States.

Should any product submitted for warranty service be found ineligible for warranty service, we will provide you with an estimate of cost of repair and will repair the product upon your request and upon receipt of payment or acceptable arrangements for payment.

WITH RESPECT TO YOU, THE COMMERCIAL PURCHASER, ALL IMPLIED WARRANTIES, INCLUDING THE IMPLIED WARRANTIES OF MERCHANTABILITY, FITNESS FOR A PARTICULAR PURPOSE, AND NON-INFRINGEMENT ARE EXCLUDED AND DISCLAIMED.

NEITHER TATUNG NOR ITS SERVICE PROVIDER SHALL BE LIABLE FOR ANY SPECIAL, INCIDENTAL OR CONSEQUENTIAL DAMAGES FOR BREACH OF ANY EXPRESS OR IMPLIED WARRANTY. TATUNG'S MAXIMUM LIABILITY IS LIMITED TO THE PURCHASE PRICE YOU PAID FOR THE PRODUCT PLUS INTEREST AS MAY BE ALLOWED BY APPLICABLE LAW. TATUNG IS NOT LIABLE TO YOU FOR EVENTS BEYOND ITS CONTROL, SUCH AS ACTS OF GOD, VIRUSES, PROPERTY DAMAGE, LOSS OF USE, INTERRUPTION OF BUSINESS, LOST PROFITS, LOST DATA, OR OTHER CONSEQUENTIAL, PUNITIVE, OR SPECIAL DAMAGES, HOWSOEVER CAUSED, WHETHER FOR BREACH OF WARRANTY, CONTRACT, TORT (INCLUDING NEGLIGENCE), STRICT LIABILITY, OR OTHERWISE

This warranty gives you specific legal rights, and you may also have other rights, which vary from state to state. This is the only express warranty applicable to the product; Tatung neither assumes nor authorizes anyone to assume for it any other express warranty. This warranty may not be modified, altered, or amended without the written agreement of Tatung which specifically states that the writing is intended to modify, alter, or amend this warranty. If any term of this warranty is illegal or unenforceable, the legality and enforceability of the remaining provisions shall not be affected or impaired.

This warranty extends only to you, the original commercial purchaser, and is not transferable to anyone who subsequently purchases, leases, or otherwise obtains the product from you.



TATUNG Co. of America, Inc
2850 El Presidio Street
Long Beach CA 90810
Tel: 1-800-829-2850 x242
www.tatungusa.com
service@tatungusa.com

For Service and Repair

*Please call us at 1-800-829-2850 ext 242 or email
service@tatungusa.com or go to www.tatungusa.com click on "Support"
then select either "Online repair Request Form" or Mail or Fax Repair
Request Form.*