



VTC-TNT8RFA4-2

Transcendent Series 8 MegaPixel
[4K] Gen. IV Advanced A.I.
Fixed IP Turret Camera

QUICK START GUIDE



4K
8MP



FEATURES:

- 1/2.8" 8.0 Megapixel [4K] CMOS Image Sensor
- NDAA Compliant
- Up to 30fps live view @ 8 MegaPixel (3840x2160)
- 2.8mm Fixed Iris Lens
- Matrix IR (up to 100' IR Range)
- True Wide Dynamic Range
- True Mechanical Day/Night function by ICR
- XD-DNR (3D & 2D-DNR) Noise Reduction
- Gen. IV Advanced Analytics: Intrusion Detection, Line Crossing, Target Counting [All by Human / Motor Vehicle Classification], Face Detection, Video Blur, Video Color Cast Detection, Abnormal Video
- H.265+ / H.265 / H.264+ / H.264 / MJPEG
- 1 Ch. Audio In + Built-in Mic*
- Remote Viewing via CMS, Internet Explorer, iOS & Android Apps
- ONVIF Compliant
- MicroSD Card Slot for Local Recording (256GB)
- IP67 Weather Resistance
- Optional Wall Mounts (VT-TWMT-3, VT-TWMT-A1 [reqs. VT-TJB08]), Junction Boxes (VT-TJB01, VT-TJB08), and Pendant Mounts (VT-TPDMT-A1 [reqs. VT-TJB08], VT-TPDM-2 [reqs. VT-TJB01]) Available (see pg. 9 for additional mounting options)
- 12VDC & PoE (Power over Ethernet) Operation
- Available in Ivory or Charcoal Grey (VTC-TNT8RFA4B-2)







*Please research local, state and federal laws regarding the implementation of audio surveillance.



PLEASE NOTE:

Complete User Guide, Software, Tools, and Updates are available online. Scan the QR Code or visit:
<http://www.vitekccv.com/Downloads>

Components and Accessories

Camera		Drill Template	
Quick Guide		Rubber Plug	
Screws		Waterproof Cap	
Hex Wrench			

Overview

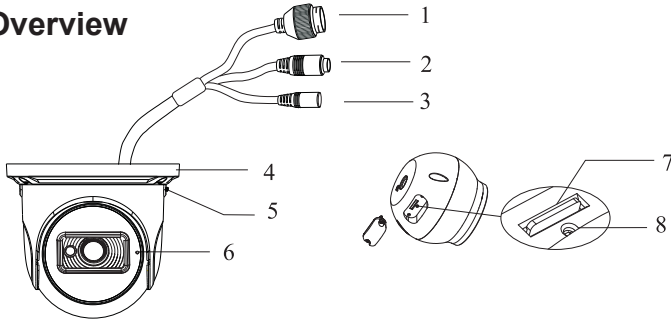

1	Ethernet connector	5	Fixed screw
2	Audio input connector	6	Microphone
3	Power connector	7	Micro SD card slot
4	Mounting base	8	Reset

Network Cable & Power Connections

First connect the Weather Resistant Cap to an Ethernet patch cable, then connect the cameras to the ethernet adaptor. If not powering the camera with PoE, also connect the power Cable to an approved 12VDC power supply.

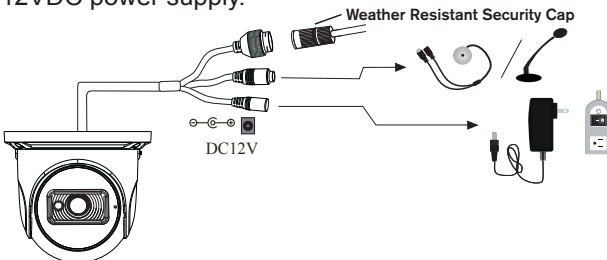

Weather Resistant Network Coupler

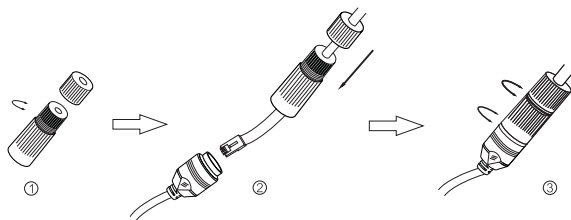

1. Loosen the nut from the Weather Resistant Network Coupler,
2. Run ethernet cable through coupler, then attach a RJ-45 connector.
3. Tighten the nut and coupler for a weather resistant seal.

Installation

Before beginning installation, make sure that the wall or ceiling is strong enough to withstand 3 times the weight of the camera.

MicroSD Card Installation: Remove the bottom of the cover from the camera, insert card and replace the cover (be sure it is even).

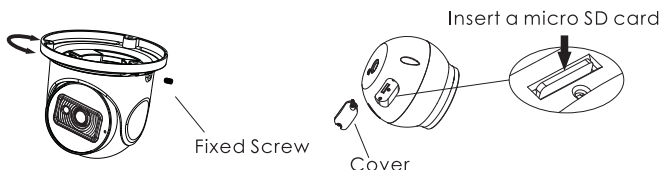

1. Attach the drill template to the place where you want to install the camera, then drill 3 screw holes and 1 cable hole (if you want to route the cables through the mounting base) according to the drill template

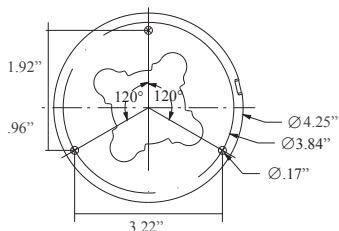

2. Route the cables and connect the power & video cables, using the rubber plug to fill the gap of the mounting base, then secure the mounting base to the ceiling or wall with screws (see fig. 2 on next page).

Fig. 2

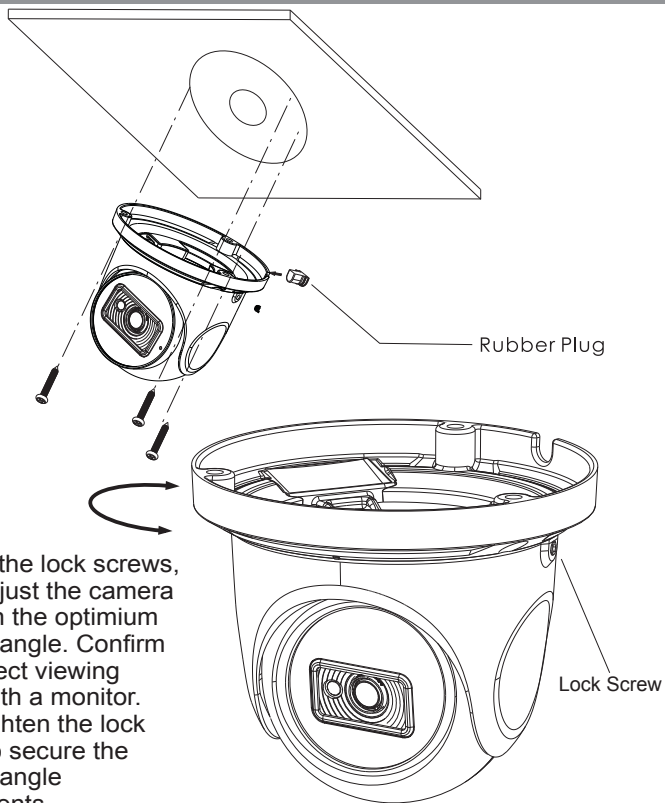

3. Loosen the lock screws, then adjust the camera to obtain the optimum viewing angle. Confirm the correct viewing angle with a monitor. Next, tighten the lock screw to secure the viewing angle adjustments.

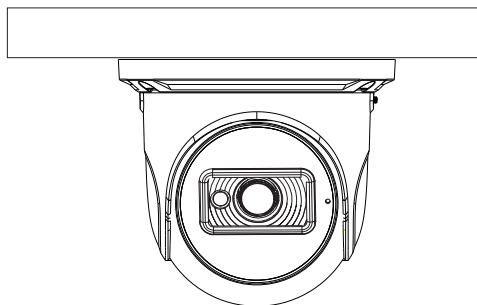

LAN Configuration

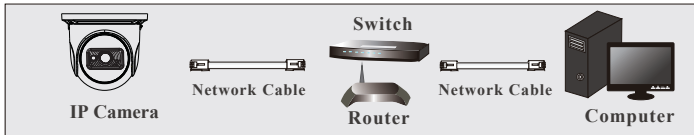

The camera can be accessed on the local network either using the IP-Tool or directly in a web browser.

Accessing the Camera Using the IP-Tool

1. Make sure the camera and PC are connected to the LAN.
2. Locate the IP-Tool installer at www.vitekctv.com/Downloads/Software/Transcendent-IPTool_v2.0.2.zip, then install on the PC. Open the installed application.



3. Modify the IP address. The default IP address is 192.168.226.201. Click the information of the camera listed in the above table to show the network information on the right side. Modify the IP address and gateway of the camera and make sure its network address is in the same local network segment as the computer's. Please modify the IP address of your device according to the practical situation.

For example, the IP address of your computer is 192.168.13.4. So the IP address of the camera shall be changed to 192.168.13.X. After modification, please input the password of the administrator and click "Modify" button to modify the setting.

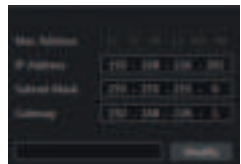

** Default admin password: "123456".

4. Double-click the IP address and then the system will pop up the web browser to connect IP-CAM . IE browser will download the Active X control. After downloading, a login window will pop up as shown below:



Input the user name and password to log in.

Default user name: admin / Default password: 123456.

Directly Access Through a Web Browser

The default network settings are as shown below:

IP address: 192.168.226.201 HTTP: 80

Subnet Mask: 255.255.255.0 Data Port: 9008

Gateway: 192.168.226.1

You may use the above default settings when you log in the camera for the first time.

1. Manually set the IP address of the PC. The network segment should be the same as the default settings of IP-CAM. Open the network and share center. Click “Local Area Connection” to pop up the following window.

Select “Properties” and then select Internet protocol according to the actual situation (for example: IPV4). Next, click “Properties” button to set the network of the PC.



2. Open the IE Browser and input the default address of IP-CAM and confirm. The IE browser will download Active X control.
3. After downloading Active X control, the login dialog box will pop up.
4. Input the default username and password and then enter to view.

WAN Configuration

Access the camera by the router or virtual server for example.

1. Make sure the camera is connected to the LAN; Then log into the camera via LAN and go to System Config→Network Config→Port menu to set up the port number.
2. Enter System Config→Network Config→IP Address menu to modify the IP address.

Port	Value
HTTP Port	80
HTTPS Port	443
Data Port	8028
RTSP Port	554

3. Go to the router's management interface through IE browser to forward the IP address and port of IP-CAM in the "Virtual Server".

Application	Start	End	Protocol	IP Address	Enable
1	8088	8088	Both	192.168.1.1	<input type="checkbox"/>
2	80	80	Both	192.168.1.1	<input checked="" type="checkbox"/>
3	10000	10001	Both	192.168.1.1	<input type="checkbox"/>
4	21000	21001	Both	192.168.1.1	<input type="checkbox"/>
5	7777	7778	Both	192.168.1.1	<input type="checkbox"/>
6	1020	1020	Both	192.168.1.1	<input type="checkbox"/>

4. Open the web browser and input its WAN IP and HTTP port to access the IP-CAM.
5. For additional setup, features and functions, please scan the QR code on the front page of this quick guide and download the complete manual.

VTC-TNT8RFA4-2 Detailed Specifications

Image Sensor	1/2.8" 8.0 Megapixel [4K] CMOS Image Sensor
Image Size	8 MegaPixel (3840 × 2160)
Resolution	8MP(3840 × 2160), 6MP(3072 × 2048), 5MP(2592 × 1944), 4MP(2592 × 1520), 3MP(2304 × 1296), 1080P(1920 × 1080), 720P(1280 × 720), D1, CIF, 480 × 240
Min. Illumination	0.01 lux @ F1.2, AGC ON; 0 lux with IR, 0.02 lux@F1.6, AGC ON; 0 lux with IR
Lens	2.8mm Fixed Iris Lens
Day / Night	True Day/Night by ICR
IR LEDs / IR Distance	1 Matrix / 100' (Smart IR)
Video Compression	H.265+ / H.265 / H.264+ / H.264 / MJPEG
Audio Compression	G.711A / G.711U
Main-Stream	1 ~ 30fps: 8MP, 6MP, 5MP, 4MP, 3MP, 1080P, 720P, D1, CIF, 480x240
Bit Rate / Type	64Kbps ~ 12Mbps
Wide Dynamic Range (WDR)	120dB Super WDR
Digital Noise Reduction (DNR)	XD-DNR (2D-DNR & 3D-DNR)
Quality	VBR (Five Levels of Adjustment) / CBR (Adjustable)
Image Setting	Saturation, Brightness, Contrast, WDR, Noise Reduction
Gen. IV Advanced Analytics	Intrusion Detection, Line Crossing, Target Counting <i>[All by Human/Motor Vehicle Classification]</i> , Face Detection, Video Blur, Video Color Cast Detection
Smart Alarm	Motion Alarm / Sensor Alarm
Region of Interest (ROI)	Each ROI to be Configured Separately
Network	RJ45
Audio	Built-in Mic + 1 Ch. Audio In*
Local Storage	MicroSD Card Slot (Up to 256GB)
Remote Viewing	CMS / Web Browser / Mobile (iOS/Android)
Supported Browsers	Microsoft Internet Explorer
Connection Protocol	ONVIF
Weather Resistance	IP67 Weather Rating
Power Input	12VDC / PoE
Power Consumption 12VDC / PoE	350mA (LEDs Off), 600mA (LEDs On) / < 9W
NDA Compliant	YES
Working Environment	-22° ~ 140° / < 95% Humidity
Weight, Dimensions	16.93 oz / 1.96 lbs / 480g, 3.77" × 4.25" (95.7 × 108mm) Dia × H

**Please research local, state and federal laws regarding the implementation of audio surveillance.*



OPTIONAL ACCESSORIES AND RELATED PRODUCTS FOR VTC-TNT8RFA4-2

VT-TJB08
Optional
Junction Box



VT-TJB01
Optional
Junction Box



VT-TWMT3
Optional Wall
Mount



VT-TPDM-2
Transcendent Universal
10" Pendant Mount. Reqs.
VT-TJB01

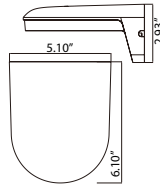
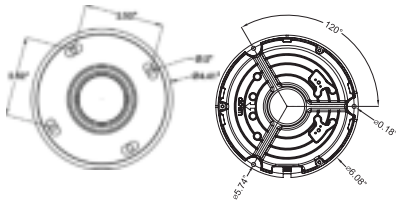

VT-TPDMT-A1
Transcendent
Universal 10"
Pendant Mount.
Reqs. VT-TJB08

VT-TWMT-A1
Transcendent
Wall Mount. Reqs.
VT-TJB08

VT-TPLMT
Transcendent
Universal Pole
Mount - Ivory,
reqs. VT-TJB08

VT-TCNMT
Transcendent
Universal Corner
Mount - Ivory,
reqs. VT-TJB08

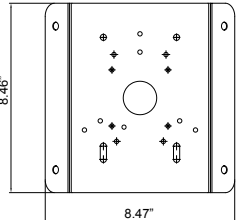
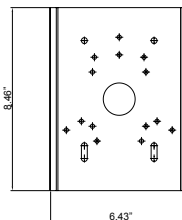
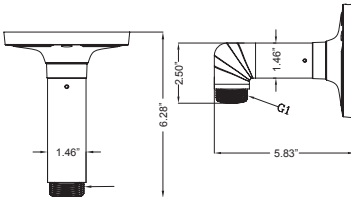



**OPTIONAL ACCESSORIES AND
RELATED PRODUCTS FOR
NDAA COMPLIANT
TRANSCENDENT IP CAMERAS**

NEWLY UPDATED

Transcendent **NVRs**

**A Standalone Solution with
Analytic Support and
NDAA Compliance!**



- **8MP (4K) HDMI Output**
- **H.265S / H.265+ / H.265 / H.264 Video Compression**
- **Analytic Support Including Basic Face Detection, License Plate Recognition, and More!**
- **Available in 4, 8, and 16 Channels**
- **Up to 24TB Depending on Model (12TB per HDD)**
- **PoE Support on ALL Models**

VT-TNR414PN
VT-TNR818PN



VT-TNR1626PN



**An Eye On
Innovation**

Also Consider Vitek NDAA Compliant Wireless Access Points to Reduce Costly Cable Installation!

VT-WAP1150 and VT-WAP2150 High Speed 5.8GHz DIP AP / CPE Wireless Bridge w/ 8MB Storage, 64MB RAM, 150Mbps transmission, and Point-to-Multi-Point (P2MP) Topology

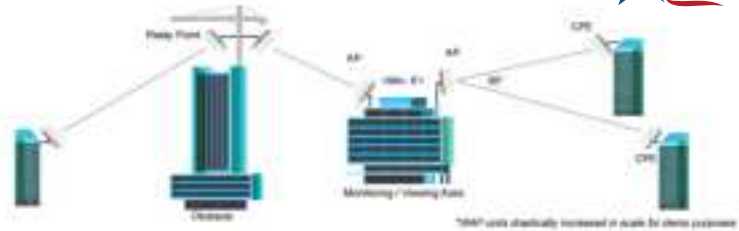

With high speed transmission of 150Mbps and a wireless range of **3000ft.** (VT-WAP1150) and **1.25 miles** (VT-WAP2150) these products eliminate the need for expensive and troublesome long-distance cables in areas where CCTV monitoring and rigorous surveillance take place. These small, lightweight and durable units are easy to install and easy to use with an innovative and straightforward 10-button plug-and-play dip switch that facilitates the creation of a robust wireless network without a computer. Set-up can be simply configured for point-to-point or point-to-multipoint topology depending on the application, with up to 128 IP group configurations!



VT-WAP1150

VT-WAP2150

LIMITED PRODUCT WARRANTY

VITEK products carry a three (3) year limited warranty. VITEK warrants to the purchaser that products manufactured by VITEK are free of any rightful claim of infringement or the like, and when used in the manner intended, will be free of defects in materials and workmanship for a period of three (3) years, or as otherwise stated above, from the date of purchase by the end user. This warranty is nontransferable and extends only to the original buyer or end user customer of a VITEK Authorized Reseller.

The product must have been used only for its intended purpose, and not been subjected to damage by misuse, willful or accidental damage, caused by excessive voltage or lightning.

The product must not have been tampered with in any way or the guarantee will be considered null and void.

This guarantee does not affect your statutory rights.

Contact your local VITEK Reseller should servicing become necessary.

VITEK makes no warranty or guarantee whatsoever with respect to products sold or purchased through unauthorized sales channels. Warranty support is available only if product is purchased through a VITEK Authorized Reseller.

