

VON DUPRIN®

88 Series

Exit device



Introduction

Your trusted solution

Our brand's reputation, respect and legacy stem from that first exit device in 1908—and they continue because of the quality of Von Duprin® products we've produced since. Today, Von Duprin remains the trusted name in the industry by engineering products that meet the highest industry standards for fire and life safety. It's this dedication to providing customers with dependable products that ensures you can put your trust in the Von Duprin brand.

The 88 Series is a wide style cross bar device. Rim, surface mounted vertical rod, concealed vertical rod and mortise configurations are available for panic and fire rated applications. The 88 Series features a non-handed design and flexible field sizing.

Passion driving performance

With superior products comes exceptional customer care. Von Duprin customers are supported by industry-leading expertise. Allegion's representatives average more than 15 years of experience, so you're assured to receive knowledgeable advice on fire and life safety codes, installation resources and more. And for those looking to take their skills to the next level, Allegion offers instructor-led workshops, videos and online courses. It's another way Von Duprin stands by our customers—today, tomorrow and for years to come.

Table of contents

Exit hardware

Rim devices

88 Rim	8
88 Rim Fire 🔥	10

Mortise lock exit devices

8875	12
8875 Fire 🔥	14

Surface mounted vertical rod exit devices

8827	16
8827 Rim Fire 🔥	18

Concealed mounted vertical rod exit devices

8847 Fire 🔥	20
-------------	----

Trim options	22
--------------	----

Strike options	24
----------------	----

Electrical options	26
--------------------	----

Accessories	27
-------------	----

UL Listing	29
------------	----

Finishes	31
----------	----



Options and accessories

Applications & trim operation	Double door applications Door handing Outside trim operation Lever styles	Electrical accessories	E8875 E373I-BE
Trim options		Device accessories	Axle security pin Cover plates Cylinders Optional levers Power supplies Vertical rod and latch guard
Strike options/ Stile information	Strike application/minimum stile strikes for rim devices	Additional information	ANSI grade, type & function Function conversion kit UL listed - fire exit hardware label opening
		Finishes	Standard & special finishes

Symbols



Indicates fire rated application



Indicates ADA products

How to order

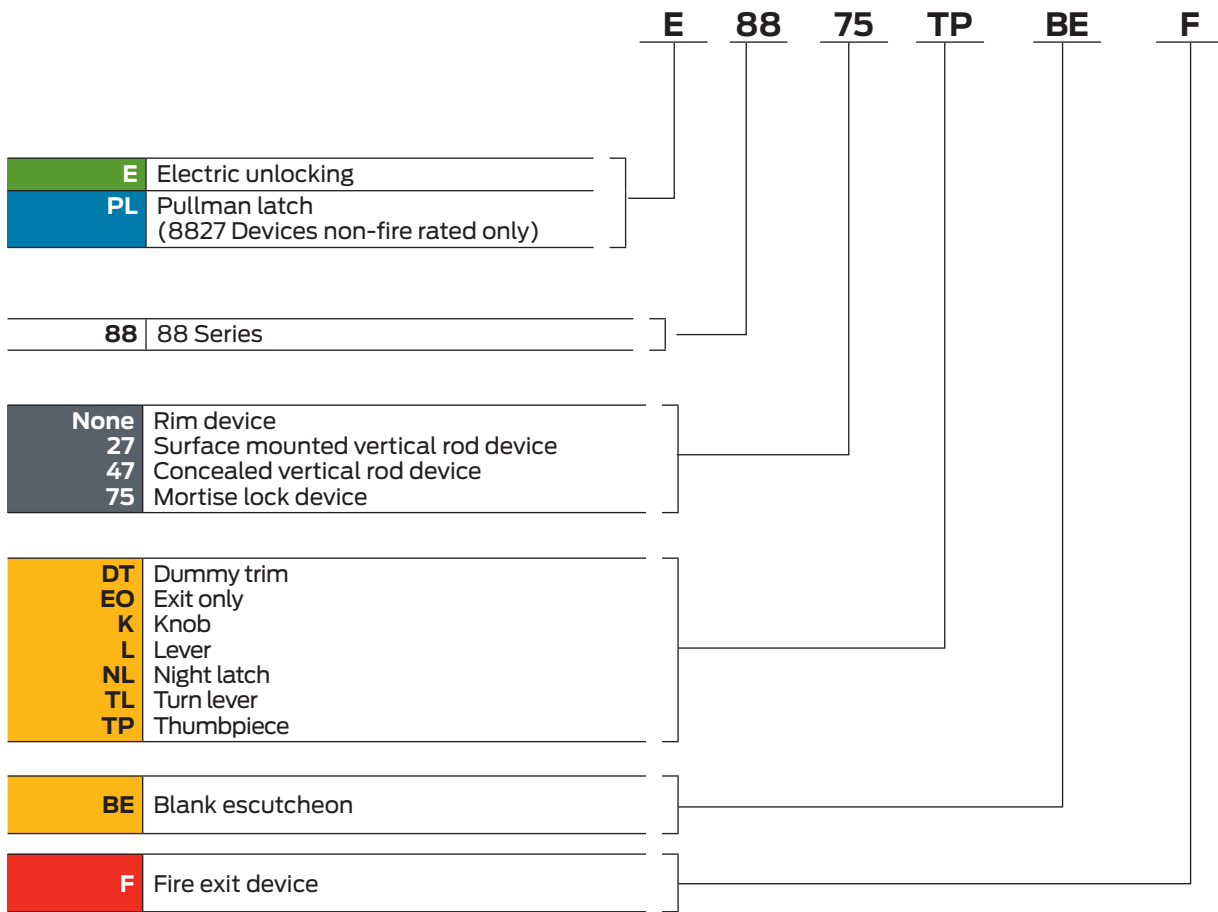

Rim and mortise lock devices, specify:

1. Exit device model number with trim selection. Examples: 88EO (Exit only with no outside trim). 88TP (Includes standard 880TP thumbpiece trim). 88TP x 608TP (Includes the optional 608TP thumbpiece trim).
2. Door width if greater than 4' (1219 mm).
3. Door thickness if other than 1 3/4" (44 mm).
4. Door and frame material if other than hollow metal.
5. Finish
6. Handing required on "L" function, "F" fire devices. Specify LHR or RHR. See diagram below.
7. "SNB" when using sex nuts and bolts.

Vertical rod devices, specify:

1. Exit device number with trim selection. Examples: 8827EO (Exit only, no outside trim). 8827TP (Includes 880TP thumbpiece trim). 8827TP x 608 TP (Includes the optional 608TP thumbpiece trim).
2. Door width of greater than 4' (1219 mm).
3. Door thickness if other than 1 3/4" (44 mm).
4. Door and frame material if other than hollow metal.
5. Door height if greater than 7' (2134 mm), extension rods must be ordered. (One piece top rod available)
6. Finish
7. Handing, LHR or RHR, required on "L" function. Specify LHR or RHR. See diagram below.
8. "SNB" when using sex nuts and bolts..

Pullman latches are optional for 8827 devices. Latchbolts remain extended at all times. Specify "Pullman Latch" when required. (Normally used with an electric strike and less bottom rod)

Popular double door applications

Double door applications

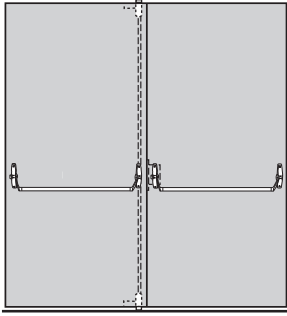

Mortise lock and vertical rod device combination — same direction

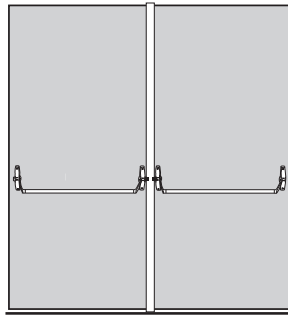

Two rim devices with mullion — same direction

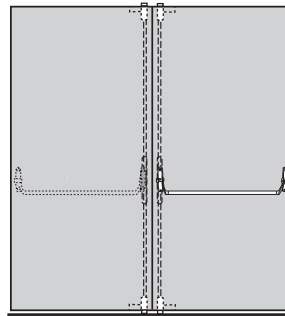

Two vertical rods — double egress

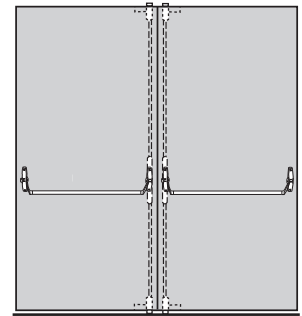

Two vertical rod devices — same direction (do not use with overlapping astragal)

Door handing

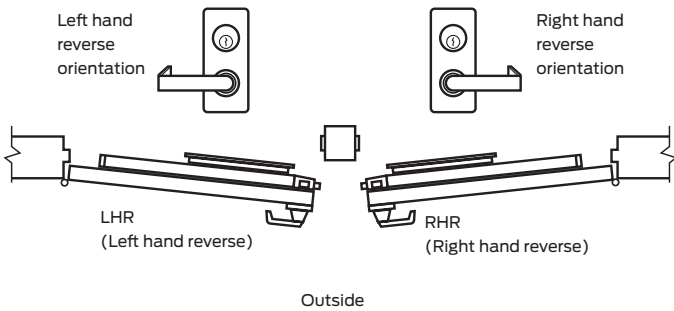

Outside trim operation

Trim operation lever

Standard operation

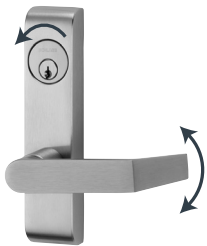

Key locks and unlocks lever.

NL Function

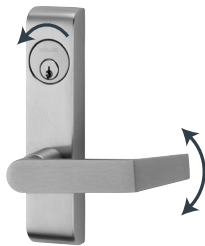

Lever will be locked when key is removed.

Blank escutcheon

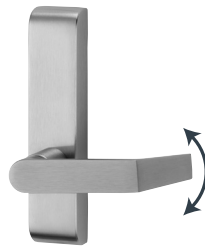

Lever always active. BE suffix, E.G., 371L-BE.



Key retracts latch bolt, knob is rigid.

K-NL function trim is locked when key is removed.

Available with 88 Rim only. To order trim, specify 880K-NL-R.

Cylinder options



Mortise — 3215 (Schlage B502-191 cams)

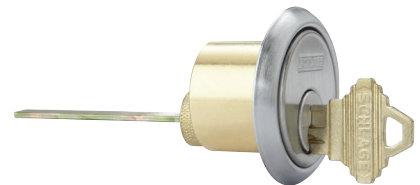

Rim — 3216

Lever styles

Standard levers



01



02



03



06
Default lever



07



12
(Handed)



17

88 Rim exit device



88 rim devices for all types of single and double doors with mullion, UL listed for accident hazard installations. Covers stock hollow metal doors with 86 or 161* cutouts. This device is field reversible.

Finishes – US26, US26D, US3, US4, US10B, US10, SPBLK

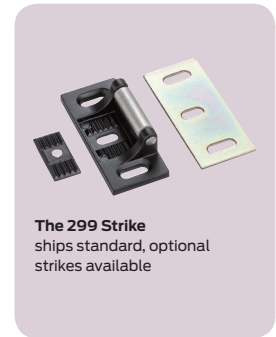

The 299 Strike ships standard, optional strikes available

Hex key dogging comes standard on 88 Rim exit devices



Specifications

Device functions	Device ships EO, DT, NL, TP, L, K	
Handing	Field reversible	
Crossbar length	42" (1067 mm) field sizeable	
Device centerline	39 ¹³ / ₁₆ "	
Crossbar centerline to finished floor	36 ¹³ / ₁₆ " (935 mm) at center	
Lock stile case	8 ¹ / ₄ " X 2 ³ / ₄ " X 1 ⁵ / ₁₆ " (210 mm x 70 mm x 24 mm)	
Hinge stile case	6" X 1 ³ / ₄ " X 1 ⁵ / ₁₆ " (152 mm x 44 mm x 24 mm)	
Crossbar tubing	1" (25 mm) outside diameter	
Projection	Neutral – 4 ³ / ₄ " (121 mm) Depressed – 4" (102 mm)	
Latch bolt	3/4" (19 mm), throw	
Fasteners	All necessary mounting fasteners are included.	
Electrical options	RX	Crossbar monitor switch in end case
	E	Electric unlocking (BE trim only)
Mechanical options	RCB	Reinforced crossbar
	KN	Knurled crossbar
Strikes	299 - Dull black	





* Not applicable with all strike and mullion combinations, consult factory.

RX





Crossbar monitor switch

- Signals use of an opening
- SPDT switch to monitor crossbar

Standard trims

	EO	NL 	TP 	DT 	K 	L 
	Exit only	Night latch Key retracts latchbolt	Key locks thumbpiece	Dummy trim Pull when dogged	Key locks knob	Key locks lever #06 Standard
Product description	88EO	88NL	88TP	88DT	88K ^{1,2,3}	88L ^{1,2,4,5,6,7}
Trim description	—	880NL-R	880TP-R	880DT-R	880K-R	373L
Escutcheon plate size	—	3" x 14 ³ / ₁₆ " x ³ / ₃₂ "	3" x 14 ³ / ₁₆ " x ³ / ₃₂ "	3" x 14 ³ / ₁₆ " x ³ / ₃₂ "	3" x 14 ³ / ₁₆ " x ³ / ₃₂ "	1 ¹¹ / ₁₆ " x 7 ¹ / ₂ " x ⁷ / ₈ "
Grip mounting center	—	5 ¹ / ₂ "	5 ¹ / ₂ "	5 ¹ / ₂ "	—	6 ¹ / ₄ "
Projection	—	2"	2"	2"	2 ³ / ₄ "	2 ⁵ / ₈ "
ANSI function	01	03	05	02	08	08/09
Cylinder type	—	Rim	Rim	—	Rim	1 ¹ / ₄ " Mortise
Sex bolt quantity #425 (optional)	8	4	4	4	4	4

Optional trims

	NL 	TP 	DT 	K 	EO 
	Night latch Key retracts latchbolt	Key locks thumbpiece	Dummy trim Pull when dogged	Key locks knob	Exit only
Product description	88NL x 608NL	88TP x 608TP	88DT x 608DT	88K x 606K ^{1,2,3,5}	88L x 880EO
Trim description	608NL-R	608TP-R	608DT-R	606K-R	880EO-R
Escutcheon plate size	1 ⁵ / ₈ " x 13 ¹ / ₂ " x ³ / ₁₆ "	1 ⁵ / ₈ " x 13 ¹ / ₂ " x ³ / ₁₆ "	1 ⁵ / ₈ " x 13 ¹ / ₂ " x ³ / ₁₆ "	1 ⁵ / ₈ " x 8 ³ / ₄ " x ³ / ₁₆ "	3" x 14 ³ / ₁₆ " x ³ / ₃₂ "
Grip mounting center	5 ¹ / ₂ "	5 ¹ / ₂ "	5 ¹ / ₂ "	—	—
Projection	2 ¹ / ₆ "	2 ¹ / ₆ "	2 ¹ / ₆ "	2 ³ / ₄ "	—
ANSI function	03	05	02	08	01
Cylinder type	Rim	Rim	—	Rim	—
Sex bolt quantity #425 (optional)	NR	NR	NR	NR	4

¹ If no cylinder operation is required, specify "BE" blank escutcheon, trim always operable; example 88TP-BE.

² Matching dummy trim available, use suffix "DT"; example 88K-DT.

³ Night latch function available, order 88NL x 880K-R rigid.

⁴ When using sex bolts, an 889 cover plate is required. See page 24.

⁵ When using on wood doors without sex bolts, "WDA" cover plate is required. See page 24.

⁶ Not available with E88.

⁷ The 373L is shipped L. An NL cylinder plate is also furnished standard (for operation only when key is used).

NR-Not recommended

Notes

88-F Rim fire exit device



88-F fire exit rim devices for all types of 4' X 8' (1219 mm X 2438 mm) single and 8' X 8' (2438 mm x 2438 mm) double doors with 9954 mullion, UL listed, 3 hours. This device is handed.

Finishes – US26, US26D, US3, US4, US10B, US10, SPBLK

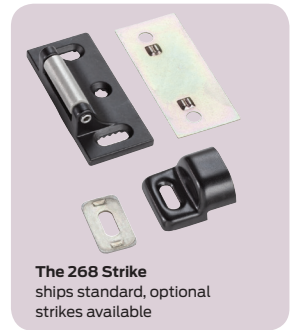

The 268 Strike ships standard, optional strikes available

Specifications

Device functions	Device ships EO, NL, TP, L, K	
Handing	Handed	
Crossbar length	42" (1067 mm) field sizeable	
Device centerline	39 ¹³ / ₁₆ "	
Crossbar centerline to finished floor	36 ¹³ / ₁₆ " (935 mm) at center	
Lock stile case	8 ¹ / ₄ " X 2 ³ / ₄ " x ¹⁵ / ₁₆ " (210 mm x 70 mm x 24 mm)	
Hinge stile case	6" X 1 ³ / ₄ " x ¹⁵ / ₁₆ " (152 mm x 44 mm x 24 mm)	
Crossbar tubing	1" (25 mm) outside diameter	
Projection	Neutral – 4 ³ / ₄ " (121 mm) Depressed – 4" (102 mm)	
Latch bolt	Deadlocking – 3/4" (19 mm), throw	
Fasteners	All necessary mounting fasteners are included.	
Electrical options	RX	Crossbar monitor switch in end case
	E	Electric unlocking (BE trim only)
Mechanical options	RCB	Reinforced crossbar
	KN	Knurled crossbar
Strikes	299 - Dull black	





RX

Crossbar monitor switch



- Signals use of an opening
- SPDT switch to monitor crossbar



Standard trims

	EO	NL	TP	K	L
					
	Exit only	Night latch Key retracts latchbolt	Key locks thumbpiece	Key locks knob	Key locks lever #06 Standard
Product description	88EO-F	88NL-F	88TP-F ¹	88K-F ^{1,5}	88L-F ^{1,2,3,4}
Trim description	—	880NL-R	880TP-R	880K-R	373L
Escutcheon plate size	—	3" x 14 ³ / ₁₆ " x ³ / ₃₂ "	3" x 14 ³ / ₁₆ " x ³ / ₃₂ "	3" x 14 ³ / ₁₆ " x ³ / ₃₂ "	1 ¹¹ / ₁₆ " x 7 ¹ / ₂ " x ⁷ / ₈ "
Grip mounting center	—	5 ¹ / ₂ "	5 ¹ / ₂ "	—	—
Projection	—	2"	2"	2 ³ / ₄ "	2 ⁵ / ₈ "
ANSI function	01	03	05	08	08/09
Cylinder type	—	Rim	Rim	Rim	1 ¹ / ₄ " Mortise
Sex bolt quantity #425 (optional) ⁶	8	4	4	4	4

Optional trims

	NL	TP	L
			
	Night latch Key retracts latchbolt	Key locks thumbpiece	Key locks knob
Product description	88NL-F x 608NL	88TP-F x 608TP	88K-F x 606K ^{1,3}
Trim description	608NL-R	608TP-R	606K-R
Escutcheon plate size	1 ⁵ / ₈ " x 13 ¹ / ₂ " x ³ / ₁₆ "	1 ⁵ / ₈ " x 13 ¹ / ₂ " x ³ / ₁₆ "	1 ⁵ / ₈ " x 13 ¹ / ₂ " x ³ / ₁₆ "
Grip mounting center	5 ¹ / ₂ "	5 ¹ / ₂ "	—
Projection	2 ¹ / ₆ "	2 ¹ / ₆ "	2 ³ / ₄ "
ANSI function	03	05	08
Cylinder type	Rim	Rim	Rim
Sex bolt quantity #425 (optional) ⁶	NR	NR	NR

¹ If no cylinder operation is required, specify "BE" blank escutcheon, trim always operable; example 88TP-F-BE.

² When using on composite or wood doors, an 889 cover plate is required. See page 24.

³ Not available with E88-F.

⁴ The 373L is shipped L. An NL cylinder plate is also furnished standard (for operation only when key is used).

⁵ Night Latch Function available, order 88NL-F x 880K-R Rigid.

⁶ Sex bolts must be used on wood or composite fire doors.

NR-Not recommended

Notes

8875 Mortise lock exit device



8875 mortise lock devices or all types of single or double doors, UL listed for accident hazard installations. Fits stock hollow metal doors with 86 cutouts and door stiles as narrow as 4 3/4" (121 mm). This device is field reversible but comes handed from factory. The 7500 mortise lock is equipped with a 3/4" (19 mm) anti-friction latch bolt which is field reversible without removing the lock from the door. It has a non-handed auxiliary bolt for deadlocking and a faceplate with an adjustable bevel. Field selection of functions are furnished standard. TP and K function may be field selected by turning down a set screw in mortise lock body. Electric locking or unlocking options are available.

Hex key dogging comes standard on 8875 Series mortise lock exit devices



Finishes – US26, US26D, US3, US4, US10B, US10, SPBLK

Specifications

Device functions	Device ships EO, DT, NL, TP, K, L	
Handing	Handed	
Crossbar length	42" (1067 mm) field sizeable	
Device centerline	39 13/16"	
Crossbar centerline to finished floor	36 13/16" (935 mm) at center	
Latch bolt height to finished floor	40 3/32" (1018 mm) at center	
Lock stile case	8 1/4" x 2 x 15/16" (210 mm x 51 mm x 24 mm)	
Lock case	4 5/8" x 5 3/4" x 1 1/16" (117 mm x 146 mm x 27 mm)	
Faceplate	1 1/4" x 8" x 7/32" (32 mm x 203 mm x 6 mm)	
Cylinder backset	2 3/4" (70 mm)	
Hinge stile case	6" x 1 3/4" x 15/16" (152 mm x 44 mm x 24 mm)	
Crossbar tubing	1" (25 mm) outside diameter	
Projection	Neutral – 4 7/8" (124 mm) Depressed – 4" (102 mm)	
Latchbolt	Deadlocking - 3/4" (19mm) throw	
Fasteners and sex bolts (SBN)	Includes screw pack for 1 3/4" (44 mm) and 2 1/4" (57 mm) thick metal or wood doors.	
Electric options	RX	Crossbar monitor switch
	E8875	Electric mortise lock device
Mechanical options	RCB	Reinforced crossbar
	KN	Knurled crossbar
Strikes	575 - Dull black	







RX
Crossbar monitor switch

- Signals use of an opening
- SPDT switch to monitor crossbar





E8875
Electric mortise lock device

- Controls locking of the outside trim

Standard trims

	EO	NL	TP	DT	K	L
						
	Exit only	Night latch Key retracts latchbolt	Key locks thumbpiece	Dummy trim Pull when dogged	Key locks knob	Key locks lever #06 Standard
Product description	8875EO	8875NL	8875TP ¹	8875DT	8875K ^{1,2}	8875L ^{1,2,3,4,5,6}
Trim description	—	880NL-M	880TP-M	880DT-M	880K-M	373L
Escutcheon plate size	—	3" x 14 ³ / ₁₆ " x ³ / ₃₂ "	3" x 14 ³ / ₁₆ " x ³ / ₃₂ "	3" x 14 ³ / ₁₆ " x ³ / ₃₂ "	3" x 14 ³ / ₁₆ " x ³ / ₃₂ "	1 ¹¹ / ₁₆ " x 7 ¹ / ₂ " x 7 ⁷ / ₈ "
Grip mounting center	—	5 ¹ / ₂ "	5 ¹ / ₂ "	5 ¹ / ₂ "	—	6 ¹ / ₄ "
Projection	—	2"	2"	2"	2 ³ / ₄ "	2 ⁵ / ₈ "
ANSI function	01	03	05	02	08	08/09
Cylinder type	—	1 ¹ / ₄ " Mortise	1 ¹ / ₄ " Mortise	—	1 ¹ / ₄ " Mortise	1 ¹ / ₄ " Mortise
Sex bolt quantity #425 (optional)	8	4	4	4	4	4

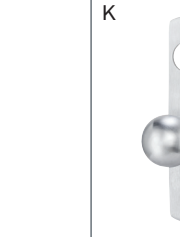
Optional trims

	NL	TP	DT	K	EO
					
	Night latch Key retracts latchbolt	Key locks thumbpiece	Dummy trim Pull when dogged	Key locks knob	Exit only
Product description	8875NL x 608NL	8875TP x 608TP	8875DT x 608DT	8875K x 606K ^{1,2}	8875L x 880EO
Trim description	608NL-M	608TP-M	608DT-M	606K-M	880EO-M
Escutcheon plate size	1 ⁵ / ₈ " x 13 ¹ / ₂ " x ³ / ₁₆ "	1 ⁵ / ₈ " x 13 ¹ / ₂ " x ³ / ₁₆ "	1 ⁵ / ₈ " x 13 ¹ / ₂ " x ³ / ₁₆ "	1 ⁵ / ₈ " x 8 ³ / ₄ " x ³ / ₁₆ "	3" x 14 ³ / ₁₆ " x ³ / ₃₂ "
Grip mounting center	5 ¹ / ₂ "	5 ¹ / ₂ "	5 ¹ / ₂ "	—	—
Projection	2 ¹ / ₆ "	2 ¹ / ₆ "	2 ¹ / ₆ "	2 ³ / ₄ "	—
ANSI function	03	05	02	08	01
Cylinder type	1 ¹ / ₄ " Mortise	1 ¹ / ₄ " Mortise	—	1 ¹ / ₄ " Mortise	—
Sex bolt quantity #425 (optional)	NR	NR	NR	NR	4

¹If no cylinder operation is required, specify "BE" blank escutcheon, trim always operable; example 8875TP-BE.

²Matching dummy trim available, use suffix "DT"; example 8875K-DT.

³When using sex bolts, an 889 cover plate is required. See page 24.

⁴When using on wood doors without sex bolts, "WDA" cover plate is required. See page 24.

⁵The 373L is shipped L. An NL cylinder plate is also furnished standard (for operation only when key is used).

⁶When used with E8875, no cylinder operation is available. Control furnished "BE".

NR-Not recommended

Notes

8875-F Mortise lock fire exit device



8875-F mortise lock fire exit devices for all types of 4' X 8' (1219 mm X 2438 mm) single and 8' X 8' (2438 mm x 2438 mm), UL listed, 3 hours. Fits door stiles as narrow as 4³/₄" (121 mm).

The 7500 mortise lock is field reversible without removing the lock from the door. It has a non-handed auxiliary bolt for deadlocking and a faceplate with an adjustable bevel. Field selection of functions are furnished standard. TP and K function may be field selected by turning down a set screw in mortise lock body. Electric locking or unlocking options are available.

Finishes – US26, US26D, US3, US4, US10B, US10, SPBLK

Hex key dogging comes standard on 8875 Series mortise lock fire exit devices



Specifications

Device functions	Device ships EO, NL, TP, K, L
Crossbar length	42" (1067 mm) field sizeable
Device centerline	39 ¹³ / ₁₆ "
Crossbar centerline to finished floor	36 ³ / ₁₆ " (935 mm) at center
Latch bolt height to finished floor	40 ³ / ₃₂ " (1018 mm) at center
Lock stile case	8 ¹ / ₄ " x 2 x ¹⁵ / ₁₆ " (210 mm x 51 mm x 24 mm)
Lock case	4 ⁵ / ₈ " x 5 ³ / ₄ " x 1 ¹ / ₁₆ " (117 mm x 146 mm x 27 mm)
Faceplate	1 ¹ / ₄ " x 8" x ⁷ / ₃₂ " (32 mm x 203 mm x 6 mm)
Cylinder backset	2 ³ / ₄ " (70 mm)
Hinge stile case	6" x 1 ³ / ₄ " x ¹⁵ / ₁₆ " (152 mm x 44 mm x 24 mm)
Crossbar tubing	1" (25 mm) outside diameter
Projection	Neutral – 4 ⁷ / ₈ " (124 mm) Depressed – 4" (102 mm)
Latchbolt	Deadlocking - ³ / ₄ " (19mm) throw
Fasteners and sex bolts (SBN)	Includes screw pack for 1 ³ / ₄ " (44 mm) and 2 ¹ / ₄ " (57 mm) thick metal or wood doors.
Electric options	RX Crossbar monitor switch E8875 Electric mortise lock device
Mechanical options	RCB Reinforced crossbar KN Knurled crossbar
Strikes	575 - Dull black

RX

Crossbar monitor switch





- Signals use of an opening
- SPDT switch to monitor crossbar

E8875



Electric mortise lock device

- Controls locking of the outside trim

Standard trims

	EO	NL 	TP 	K 	L 
	Exit only	Night latch Key retracts latchbolt	Key locks thumbpiece	Key locks knob	Key locks lever #06 Standard
Product description	8875EO-F	8875NL-F	8875TP-F ¹	8875K-F ¹	8875L-F ^{1,2,3,4}
Trim description	—	880NL-M	880TP-M	880K-M	373L
Escutcheon plate size	—	3" x 14 ³ / ₁₆ " x ³ / ₃₂ "	3" x 14 ³ / ₁₆ " x ³ / ₃₂ "	3" x 14 ³ / ₁₆ " x ³ / ₃₂ "	1 ¹ / ₁₆ " x 7 ¹ / ₂ " x ⁷ / ₈ "
Grip mounting center	—	5 ¹ / ₂ "	5 ¹ / ₂ "	—	—
Projection	—	2"	2"	2 ³ / ₄ "	2 ⁵ / ₈ "
ANSI function	01	03	05	08	08/09
Cylinder type	—	1 ¹ / ₄ " Mortise	1 ¹ / ₄ " Mortise	1 ¹ / ₄ " Mortise	1 ¹ / ₄ " Mortise
Sex bolt quantity #425 (optional)	8	4	4	4	4

Optional trims

	NL 	TP 	L 
	Night latch Key retracts latchbolt	Key locks thumbpiece	Key locks knob
Product description	8875NL-F x 608NL	8875TP-F x 608TP ¹	8875K-F x 606K ¹
Trim description	608NL-M	608TP-M	606K-M
Escutcheon plate size	1 ⁵ / ₈ " x 13 ¹ / ₂ " x ³ / ₁₆ "	1 ⁵ / ₈ " x 13 ¹ / ₂ " x ³ / ₁₆ "	1 ⁵ / ₈ " x 13 ¹ / ₂ " x ³ / ₁₆ "
Grip mounting center	5 ¹ / ₂ "	5 ¹ / ₂ "	—
Projection	2 ¹ / ₆ "	2 ¹ / ₆ "	2 ³ / ₄ "
ANSI function	03	05	08
Cylinder type	1 ¹ / ₄ " Mortise	1 ¹ / ₄ " Mortise	1 ¹ / ₄ " Mortise
Sex bolt quantity #425 (optional)	NR	NR	NR

¹ If no cylinder operation is required, specify "BE" blank escutcheon, trim always operable; example 8875TP-F-BE.

² When using on composite or wood doors, an 889 cover plate is required. See page 24.

³ The 373L is shipped L. An NL cylinder plate is also furnished standard (for operation only when key is used).

⁴ When used with E8875-F, no cylinder operation is available. Control furnished "BE".

⁵ Sex bolts must be used on wood or composite fire doors.

NR-Not recommended

Notes

8827 Surface mounted vertical rod exit device



8827 surface mounted vertical rod devices for all types of single and double doors, UL listed for accident hazard installations. Covers stock hollow metal doors with 86 cutout and fits door stiles as narrow as 2½" (90 mm). This device is field sizeable.

Finishes – US26, US26D, US3, US4, US10B, US10, SPBLK



Specifications

Device functions	Field reversible Device ships EO, DT, TP, K, L, TL
Crossbar length	42" (1067 mm) field sizeable
Device centerline	39 ³ / ₁₆ "
Crossbar centerline to finished floor	36 ³ / ₁₆ " (935 mm) at center
Lock stile case	8 1/4" x 2 x ¹⁵ / ₁₆ " (210 mm x 51 mm x 24 mm)
Hinge stile case	6" x 1 ³ / ₄ " x ¹⁵ / ₁₆ " (152 mm x 44 mm x 24 mm)
Top and bottom latch case	4" x 2" x 1 ⁷ / ₈ " (102mm x 51mm x 48mm).
Faceplate	1 ¹ / ₄ " x 8" x ⁷ / ₃₂ " (32 mm x 203 mm x 6 mm)
Cylinder backset	2 ³ / ₄ " (70 mm)
Crossbar tubing	1" (25 mm) outside diameter
Projection	Neutral – 4 ⁷ / ₈ " (124 mm) Depressed – 4" (102 mm)
Latchbolt	⁵ / ₈ " (16mm) throw
Fasteners and sex bolts (SBN)	Includes screw pack for 1 ³ / ₄ " (44 mm) and 2 ¹ / ₄ " (57 mm) thick metal or wood doors.
Rods/Latch guards	LBR (Less bottom rod) available for use with electric strike mounted in header and device supplied with pullman latch.
Electrical options	RX Crossbar monitor switch in end case E Electric unlocking (BE trim only)
Mechanical options	RCB Reinforced crossbar KN Knurled crossbar PL Pullman latch top and bottom
Strikes	Top 299 - Dull black Bottom 248L-4 and 304L - unfinished

Note: Maximum door undercut, 1/4" (6mm).





Hex key dogging comes standard on 8827 Series surface mounted vertical rod exit device







RX Crossbar monitor switch

- Signals use of an opening
- SPDT switch to monitor crossbar

Standard trims

	EO	TP 	DT 	K 	L 	T 
	Exit only	Key locks thumbpiece	Pull when dogged	Key locks knob	Key locks lever #06 Standard	Key locks thumbturn (Pull required)
Product description	8827EO	8827TP ^{1,2}	8827DT	8827K ^{1,2,3}	8827L ^{1,2,4,5,6}	8827TL ^{1,5,6}
Trim description	—	880TP-V	880DT-V	880K-V	373L	377T x 880DT-V
Escutcheon plate size	—	3" x 14 ³ / ₁₆ " x ³ / ₃₂ "	3" x 14 ³ / ₁₆ " x ³ / ₃₂ "	3" x 14 ³ / ₁₆ " x ³ / ₃₂ "	11 ¹ / ₁₆ " x 7 ¹ / ₂ " x ⁷ / ₈ "	11 ¹ / ₁₆ " x 7 ¹ / ₂ " x ⁷ / ₈ "
Grip mounting center	—	5 ¹ / ₂ "	5 ¹ / ₂ "	—	—	—
Projection	—	2"	2"	2 ³ / ₄ "	2 ⁵ / ₈ "	1 ¹³ / ₁₆ "
ANSI function	01	05	02	08	08/09	11/12
Cylinder type	—	Rim	—	Rim	1 ¹ / ₄ " Mortise	1 ¹ / ₄ " Mortise
Sex bolt quantity #425 (optional)	16	12	12	12	12	12

Optional trims

	TP 	DT 	K 	EO 
	Key locks thumbpiece	Dummy trim Pull when dogged	Key locks knob	Exit only
Product description	8827TP x 608TP ^{1,3}	8827DT x 608DT	8827K x 606K ^{1,3}	8827L x 880EO
Trim description	608TP-V	608DT-V	606K-V	880EO-V
Escutcheon plate size	1 ⁵ / ₈ " x 13 ¹ / ₂ " x ³ / ₁₆ "	1 ⁵ / ₈ " x 13 ¹ / ₂ " x ³ / ₁₆ "	1 ⁵ / ₈ " x 8 ³ / ₄ " x ³ / ₁₆ "	3" x 14 ³ / ₁₆ " x ³ / ₃₂ "
Grip mounting center	5 ¹ / ₂ "	5 ¹ / ₂ "	—	—
Projection	2 ¹ / ₆ "	2 ¹ / ₆ "	2 ³ / ₄ "	—
ANSI function	03	02	08	01
Cylinder type	Rim	—	Rim	—
Sex bolt quantity #425 (optional)	NR	NR	NR	12

¹ If no cylinder operation is required, specify "BE" blank escutcheon, trim always operable; example 8827TP-BE.

² Matching dummy trim available, use suffix "DT"; example 8827K-DT.

³ Can be furnished with NL action, thumbpiece or knob operates only when key is used. Use suffix NL; example 8827TP-NL.

⁴ When using sex bolts, an 889 cover plate is required. See page 24.

⁵ When using on wood doors without sex bolts, "WDA" cover plate is required. See page 24.

⁶ The 373L and 377T are shipped L or TL. An NL cylinder plate is also furnished standard (for operation only when key is used).

NR-Not recommended

Notes

8827-F Surface mounted vertical rod fire exit device



8827-F surface mounted vertical rod devices for all types of 8' X 8' (2438 mm x 2438 mm), UL listed, 3 hours. Fits door stiles as narrow as 3³/₄" (95 mm). This device is field reversible.

Finishes – US26, US26D, US3, US4, US10B, US10, SPBLK



Hex key dogging comes standard on 8827 Series surface mounted vertical rod fire exit device







RX
Crossbar monitor switch
 • Signals use of an opening
 • SPDT switch to monitor crossbar

Specifications



Device functions	Field reversible Device ships EO, TP, K, L, TL
Crossbar length	42" (1067 mm) field sizeable
Device centerline	39 ³ / ₁₆ "
Crossbar centerline to finished floor	36 ¹³ / ₁₆ " (935 mm) at center
Lock stile case	8 1/4" x 2 x 15/16" (210 mm x 51 mm x 24 mm)
Top and bottom latch case	4" x 2" x 1 7/8" (102mm x 51mm x 48mm).
Faceplate	1 1/4" x 8" x 7/32" (32 mm x 203 mm x 6 mm)
Cylinder backset	2 3/4" (70 mm)
Hinge stile case	6" x 1 3/4" x 15/16" (152 mm x 44 mm x 24 mm)
Crossbar tubing	1" (25 mm) outside diameter
Projection	Neutral – 4 7/8" (124 mm) Depressed – 4" (102 mm)
Latchbolt	5/8" (16mm) throw
Fasteners and sex bolts (SBN)	Includes screw pack for 1 3/4" (44 mm) and 2 1/4" (57 mm) thick metal or wood doors.
Electrical options	RX Crossbar monitor switch in end case E Electric unlocking (BE trim only)
Mechanical options	RGB Reinforced crossbar KN Knurled crossbar PL Pullman latch top and bottom
Strikes	Bottom - 304L

8827-F Surface mounted vertical rod fire exit device

Standard trims

	EO	TP 	K 	L 	T 
	Exit only	Key locks thumbpiece	Key locks knob	Key locks lever #06 Standard	Key locks thumbturn (Pull required)
Product description	8827EO-F	8827TP-F ^{1,5}	8827K-F ^{1,5}	8827L-F ^{1,2,4}	8827TL-F ^{1,2,4}
Trim description	—	880TP-V	880K-V	373L	377T x 880DT-V
Escutcheon plate size	—	3" x 14 ³ / ₁₆ " x 3 ³ / ₃₂ "	3" x 14 ³ / ₁₆ " x 3 ³ / ₃₂ "	1 ¹¹ / ₁₆ " x 7 ¹ / ₂ " x 7 ⁷ / ₈ "	1 ¹¹ / ₁₆ " x 7 ¹ / ₂ " x 7 ⁷ / ₈ "
Grip mounting center	—	5 ¹ / ₂ "	—	—	—
Projection	—	2"	2 ³ / ₄ "	2 ⁵ / ₈ "	1 ¹³ / ₁₆ "
ANSI function	01	05	08	08/09	11/12
Cylinder type	—	Rim	Rim	1 ¹ / ₄ " Mortise	1 ¹ / ₄ " Mortise
Sex bolt quantity #425 (optional) ⁶	16	12	12	12	12

Optional trims

	TP 	K 
	Key locks thumbpiece	Key locks knob
Product description	8827TP-F x 608TP	8827K-F x 606K ¹
Trim description	608TP-V	606K-V
Escutcheon plate size	1 ⁵ / ₈ " x 13 ¹ / ₂ " x 3 ³ / ₁₆ "	1 ⁵ / ₈ " x 8 ³ / ₄ " x 3 ³ / ₁₆ "
Grip mounting center	5 ¹ / ₂ "	—
Projection	2 ¹ / ₆ "	2 ³ / ₄ "
ANSI function	05	08
Cylinder type	Rim	Rim
Sex bolt quantity #425 (optional)	NR	NR

¹ If no cylinder operation is required, specify "BE" blank escutcheon, trim always operable; example 8827TP-F-BE.

² When using on composite or wood doors, an 889 cover plate is required. See page 24.

³ When using on wood doors "WDA" cover plate is required. See page 24.

⁴ The 373L and 377T are shipped L or TL. An NL cylinder plate is also furnished standard (for operation only when key is used).

⁵ Can be furnished with NL action, thumbpiece of knob operates only when key is used. Used suffix NL; example 8827TP-NL-F.

⁶ Sex bolts must be used on wood or composite fire doors.

NR-Not recommended

Notes

8847-F Concealed vertical rod fire exit device



8847-F fire exit concealed vertical rod devices for all types of 8'x8' (2438 mm x 2438 mm) double metal doors, UL listed, 3 hours and fits door stiles as narrow as 4³/₄" (121mm).

Finishes – US26, US26D, US3, US4, US10B, US10, SPBLK

Specifications



Device functions	EO, L, TL	
Handing	Field reversible	
Crossbar length	42" (1067 mm) field sizeable	
Device centerline	39 ¹³ / ₁₆ "	
Crossbar centerline to finished floor	36 ¹³ / ₁₆ " (935 mm) at center	
Lock stile case	8 ¹ / ₄ " x 2 x ¹⁵ / ₁₆ " (210 mm x 51 mm x 24 mm)	
Hinge stile case	6" x 1 ³ / ₄ " x ¹⁵ / ₁₆ " (152 mm x 44 mm x 24 mm)	
Crossbar projection	Neutral – 4 ⁷ / ₈ " (124 mm) Depressed – 4" (102 mm)	
Crossbar tubing	1" (25 mm) outside diameter	
Vertical rod	³ / ₈ " (10 mm) hexagon	
Latchbolt	⁵ / ₈ " (16mm) throw	
Fasteners	All necessary mounting fasteners are included.	
Electrical options	RX	Crossbar monitor switch in end case
	E	Electric unlocking (BE trim only)
Mechanical options	RCB	Reinforced crossbar
	KN	Knurled crossbar
Strikes	301L Strike-bottom	

RX

Crossbar monitor switch

- Signals use of an opening
- SPDT switch to monitor crossbar

Standard trims









	EO	L	T
	Exit only	 Key locks knob	 Key locks lever #06 Standard
Product description	8847EO-F	8847L-F ^{1,2}	8847TL-F ^{1,2}
Trim description	—	371L	376T x 880DT-V-SA
Escutcheon plate size	—	1 ¹¹ / ₁₆ " x 7 1/2" x 7/8"	1 ¹¹ / ₁₆ " x 7 1/2" x 7/8"
Grip mounting center	—	—	—
Projection	—	2 ⁵ / ₈ "	1 ¹³ / ₁₆ "
ANSI function	01	08/09	11/12
Cylinder type	—	1 1/4" Mortise	1 1/4" Mortise
Sex bolt quantity #425 (optional) ⁶	4	4	4

¹ If no cylinder operation is required, specify "BE" blank escutcheon, trim always operable; example 8847L-F-BE.

² The 371 and 376T are shipped L or TL. An NL cylinder plate is also furnished standard (for operation only when key is used).

Notes

Trim options

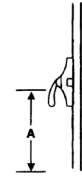
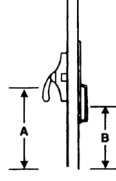
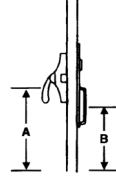
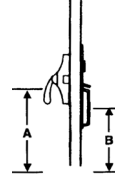
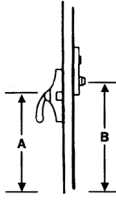
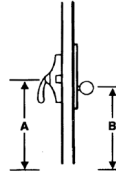
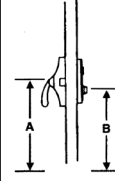
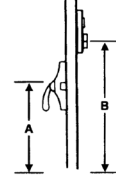
Function	01 Exit only	02 Pull when dogged	03 Key retracts latch bolt	05 Key retracts thumbpiece	06 Key locks lever	08 Key locks knob	08 Key locks lever	11/12 Key locks thumbturn	
Trim number and dimensions	880EO 	880DT 	880NL 	880TP 	371-L 	880K 	373-L 	377T or 376T x 880DT-V 	
Device/trim center line to finished floor									
Projection	—	2" (51 mm)	2" (51 mm)	2" (51 mm)	2 ⁵ / ₈ " (67 mm)	2 ³ / ₄ " (70 mm)	2 ⁵ / ₈ " (67 mm)	1 ¹³ / ₁₆ " (46 mm)	
Rim	Panic	880EO	88DT	88NL	88TP	—	88K	88L	—
	Fire	88EO-F	—	88NL-F▲	88TP-F▲	—	88K-F▲	88L-F■	—
Ctr. line	A 39 ¹³ / ₁₆ (1011 mm) —	A 39 ¹³ / ₁₆ (1011 mm) B 33 ¹¹ / ₃₂ (847mm)	A 39 ¹³ / ₁₆ (1011 mm) B 33 ¹¹ / ₃₂ (847mm)	A 39 ¹³ / ₁₆ (1011 mm) B 33 ¹¹ / ₃₂ (847mm)	—	A 39 ¹³ / ₁₆ (1011 mm) B 36 ¹³ / ₁₆ (935 mm)	A 39 ¹³ / ₁₆ (1011 mm) B 36 ¹³ / ₁₆ (935 mm)	—	
Mortise lock	Panic	8875EO	8875DT	8875NL	8875TP	—	8875K	8875L	—
	Fire	8875EO-F	—	8875NL-F	8875TP-F	—	8875K-F	8875L-F	—
Ctr. line	A 39 ¹³ / ₁₆ (1011 mm) —	A 39 ¹³ / ₁₆ (1011 mm) B 33 ¹ / ₂ (851 mm)	A 39 ¹³ / ₁₆ (1011 mm) B 33 ¹ / ₂ (851 mm)	A 39 ¹³ / ₁₆ (1011 mm) B 33 ¹ / ₂ (851 mm)	—	A 39 ¹³ / ₁₆ (1011 mm) B 38 ⁹ / ₁₆ (979 mm)	A 39 ¹³ / ₁₆ (1011 mm) B 38 ⁹ / ₁₆ (979 mm)	—	
Surface mounted vertical rod	Panic	8827EO	8827DT	—	8827TP	—	8827K	8827L	8827TL
	Fire	8827EO-F	—	—	8827TP-F	—	8827K-F	8827L-F	8827TL-F
Ctr. line	A 39 ¹³ / ₁₆ (1011 mm) —	A 39 ¹³ / ₁₆ (1011 mm) B 33 ¹ / ₂ (851 mm)	—	A 39 ¹³ / ₁₆ (1011 mm) B 33 ¹ / ₂ (851 mm)	—	A 39 ¹³ / ₁₆ (1011 mm) B 38 ⁵ / ₁₆ (973 mm)	A 39 ¹³ / ₁₆ (1011 mm) B 38 ⁵ / ₁₆ (973 mm)	A 39 ¹³ / ₁₆ (1011 mm) B 53 ¹ / ₂ (1359 mm)	
Concealed vertical rod	Fire	8847EO-F	—	—	—	8847L-F	—	—	8847TL-F
	Ctr. line	A 39 ¹³ / ₁₆ (1011 mm) —	—	—	—	A 39 ¹³ / ₁₆ (1011 mm) B 41 ¹ / ₁₆ (1059 mm)	—	—	A 39 ¹³ / ₁₆ (1011 mm) B 53 ¹ / ₂ (1359 mm)
Additional snb requirements	4/8/16	4, 12	4	4, 12	4	4, 12	4, 12	4	
Cylinder type required	Rim	—	—	Rim	Rim	—	Rim	Mortise	—
	Mortise	—	—	Mortise	Mortise	—	Mortise	Mortise	—
	Vert. rod	—	—	—	Rim	—	Rim	Mortise	Mortise
	C.V.R.	—	—	—	—	Mortise	—	—	Mortise

▲ Requires stainless steel trim for wood or composite fire doors.
 n Requires 889 Plate for wood or composite fire doors.

Note: 8827-F uses 377T, 8847-F uses 376T.

Trim options

Standard trim

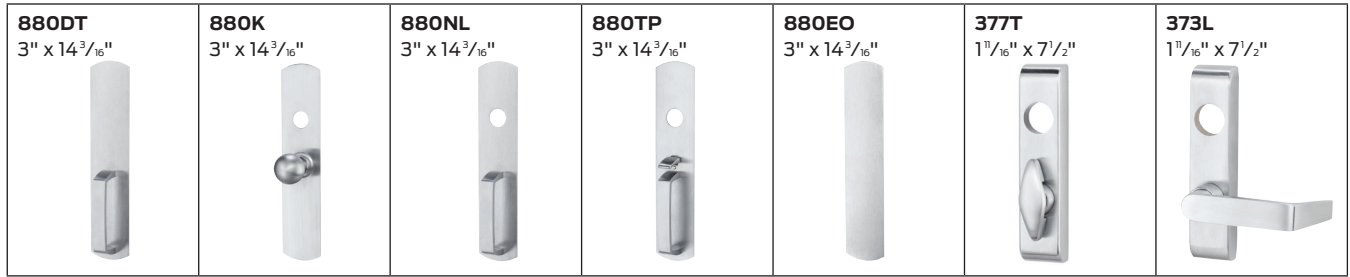

880 Series trim

Heavy 10 gauge (2.4 mm) brass, bronze, or stainless steel. Available functions: 880DT, 880K, 880NL, and 880TP. Optional 880EO exit only trim plate is available. To order with the exit device, specify 88EOx880EO.

373L/371L Series trim

Lever control has a forged brass $\frac{7}{8}''$ (22 mm) thick escutcheon. An NL cylinder plate is included for lever operation only when key is used. BE blank escutcheon is available, specify 373L-BE.

*880 Stainless Steel Trim used with fire rated rim device on wood doors.

377T Series trim

Thumbturn control has a forged brass $\frac{7}{8}''$ (22 mm) thick escutcheon. Often used with DT trim or pull. An NL cylinder plate is included for thumbturn operation only when key is used. BE blank escutcheon is available, specify 377T-BE

Optional trim



608 Series trim

Narrow design $\frac{3}{16}''$ (5 mm) thick brass, bronze, or stainless steel with flat pull grip. Available functions: 608DT, 608NL, and 608TP. When ordering with the exit device, specify 88NLx608NL.

606K Series trim

Narrow design knob trim $\frac{3}{16}''$ (5 mm) thick brass, bronze, or stainless steel $\frac{3}{16}''$ (5 mm) escutcheon.

Strike/Stile information

Strike application/Minimum stile

Device type	Standard single door		Standard double door		OPTIONAL single door		OPTIONAL double door	
	Strike	Stile	Strike w/mullion	Stile	Strike	Stile	Strike w/mullion***	STILE
88	299	4 1/8" (111 mm)	299 x 4954	4 11/16" (119 mm)	264	4 7/8" (105 mm)	299 x 5254/5654	4 7/8" (105 mm)
					1409	3 7/8" (86 mm)	264 x 5254/5654 264 x 4954	4" (107 mm) 4 7/8" (113 mm)
					1606	3 7/8" (100 mm)	1606 x 1654	4 7/8" (108 mm)
					—	—	1609*	4" (107 mm)
					—	—	1610**	4 7/8" (113 mm)
88-F	268	4 7/8" (111 mm)	268 x 9954	4 7/8" (119 mm)	—	—	—	—
8875	STRIKE	STILE	STRIKE	STILE	STRIKE	STILE	STRIKE	STILE
	575	4 7/8" (121 mm)	—	—	—	—	575-2 576A-576B	4 7/8" (121 mm)
8875-F	575	4 7/8" (121 mm)	—	—	—	—	575-2 576A-576B	4 7/8" (121 mm)
8827	STRIKE	STILE	STRIKE	STILE				
	299 (top)		Single door	2 7/8" (71 mm)	260U (top)		Single Door	2 7/8" (71 mm)
	304L/248L-4 (bottom)		Two vertical rod devices	2 7/8" (64 mm)	385A (bottom)		Two Vertical Rod Devices	2 7/8" (64 mm)
8827-F	Soffit latch (top) (bottom) 304L		Vertical rod w/mortise lock device	4 7/8" (121 mm)	385A (bottom)		Vertical Rod w/Mortise Lock Device	4 7/8" (121 mm)
			Two vertical rod devices	3 7/8" (95 mm)			Vertical rod w/mortise lock device	4 7/8" (121 mm)
8847-F	Soffit Latch (Top) 301L (Bottom)		Two vertical rod devices	4 3/4" (121 mm)				
			Vertical rod w/mortise lock device	4 3/4" (121 mm)				

*Use for rim/vertical rod combination — consult factory.

**Use for rim/vertical rod combination on stock hollow metal doors — consult factory.

***For mullion information, refer to the General and Auxiliary catalog.

Strike options

Strikes for rim devices

264

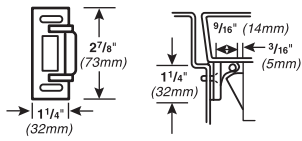

Projection $\frac{9}{16}$ " (14 mm)

268

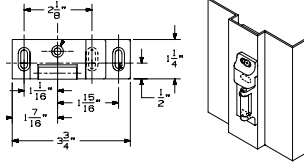

Projection $\frac{13}{16}$ " (21 mm)

299

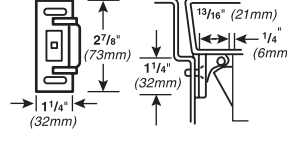

Projection $\frac{13}{16}$ " (21 mm)

1409 – Blade stop

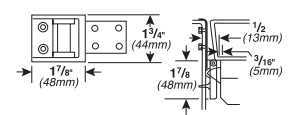

Projection $\frac{1}{2}$ " (13 mm)

1606

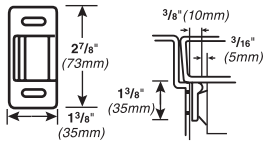

Projection $\frac{3}{8}$ " (10 mm)

1609

For rim/vertical rod, panic only
consult factory

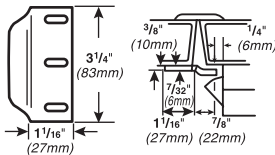

Strikes for vertical rod devices

248L-4

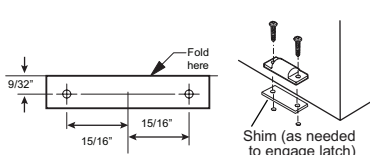

Projection $\frac{3}{8}$ " (10 mm)

260U – Flush transom only

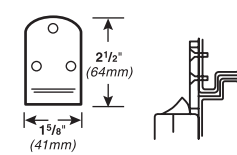

Projection $\frac{3}{8}$ " (10 mm)

264

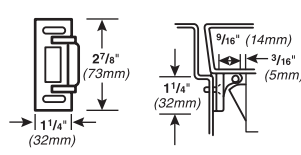

Projection $\frac{5}{8}$ " (16 mm)

299

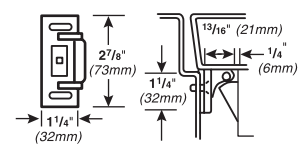

Mortise $2\frac{1}{2}$ " (64 mm)

301L

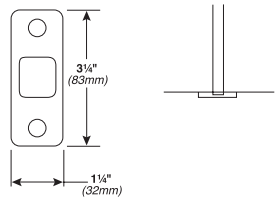

Mortise $\frac{3}{4}$ " (19 mm)

304L

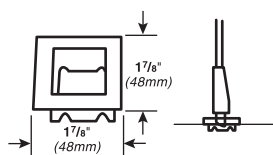

Mortise $\frac{13}{16}$ " (21 mm)

385A

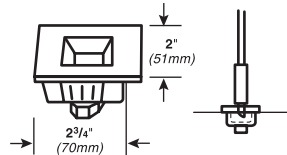

Mortise $2\frac{1}{2}$ " (64 mm)

Strikes for rim devices

575

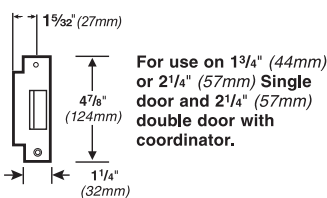

575-2

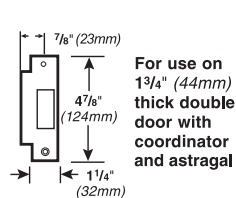

576A

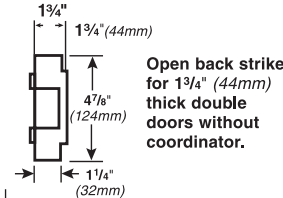

576B

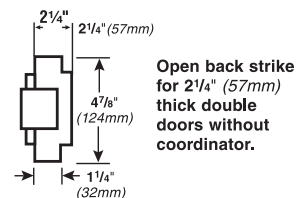

– Not for use with astragals
– For use on wood doors, contact door manufacturer

– Acceptable for 90 minute pair of hollow metal doors

88 Electrical options

E8875 Electric mortise lock device



The E8875 electric mortise lock device has all the versatility and advantages of the 8875 mortise lock device, plus the advantage of being electrically controllable by a remote switching device, an access control or automatic device, or an automatic fire alarm system. The E8875 feature controls the locking of the outside trim. When unlocked, the door remains latched, preserving the fire rating of the door and making it particularly useful where codes permit locking, but require unlocking during a fire emergency. Key override is an NL type function.

Standard features:

- Field reversible mortise lock
- 24 VDC continuous duty solenoid
- Tamper resistant (auxiliary dead latch)
- Silent operation
- Corrosion resistant
- Signaling functions
- Key mechanically retracts latchbolt

Optional features:

- Fail safe (locked when energized, unlocked when de-energized or during power failure, specify with suffix "FS").
- Fail secure (unlocked when energized — specify with suffix "FSE"). Outside trim automatically relocks, unless held unlocked electrically.
- 24 VAC (by adding SO option).
- 12 VDC or 12 VAC with SO option.

To order, specify:

- 1a. E8875 or E8875F.
- 1b. E7500 (if lock only is required).
2. FS or FSE.
3. Voltage.
4. Handing, LHR or RHR
5. Outside trim. "TP", "TP-BE", "K", "K-BE" or "L-BE" function only. When using with "L" function, no cylinder operation is available. Outside control is furnished "BE".

E373L-BE/E371L-BE

FS or FSE lever control for electric unlocking of lever.

E373L-BE

For use with rim and surface vertical rod.

E371L-BE

For use with concealed vertical rod.

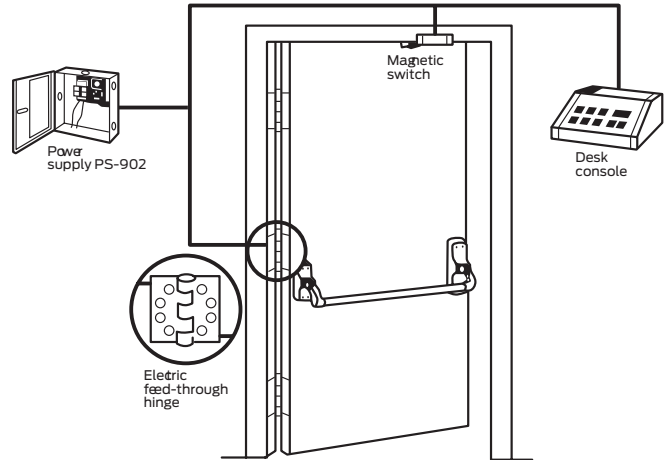

Adaptable for openings where continuous latching is required while the trim may be electrically locked or unlocked from a remote location — stairwells, exterior doors, etc.

88 Device options & accessories

RG-27 Vertical rod and latch guard

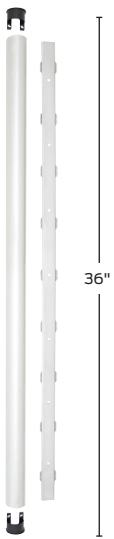

Rod guard

Series RG-27 Vertical rod and latch guards protect the bottom rods of exit devices from the damaging impacts of carts or gurneys passing through doors. (If bottom rods become damaged, the exit device will not function as intended and can jeopardize the ability to exit safely during an emergency.)

In addition to protecting the vertical rod, the guard provides a smooth, unobstructed surface so the door can be pushed open easily with the bumpers of a wheelchair. The latch guard portion is 10" high. The standard latch guard features a 45° ramp. The extended latch guard offers a continuous ramp in 3' or 4' widths.

All stainless steel construction in US32D finish. Latch guards can cover latches as large as 1 1/4"W x 10"H x 1 7/8" projection.

36"

Latch guard

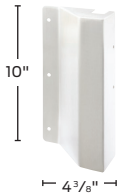

Extended latch guard

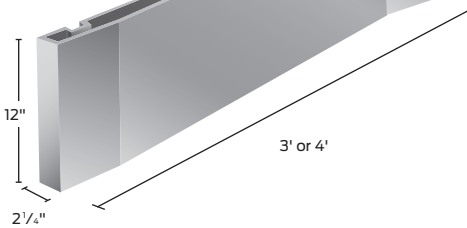

Models

- RGO Rod guard only (projection 1 3/8")
- RG-27 Rod and latch guard
- RG-27-3 3' (914mm) Rod guard and extended latch guard
- RG-27-4 4' (1219mm) Rod guard and extended latch guard
- LGO Latch guard only
- LGO-3 3' (914mm) Extended latch guard only
- LGO-4 4' (1219mm) Extended latch guard only

When using on wood fire doors, high density block is required.

To order, specify:

1. Model number.
2. Handing (except on RGO).
3. Door material if other than hollow metal.
4. Optional sex bolt mounting available.

Device options & accessories

Cover plate kits

Device

882 Kit

For use to cover mortise lock or discontinued device cut-outs. Specify finish.

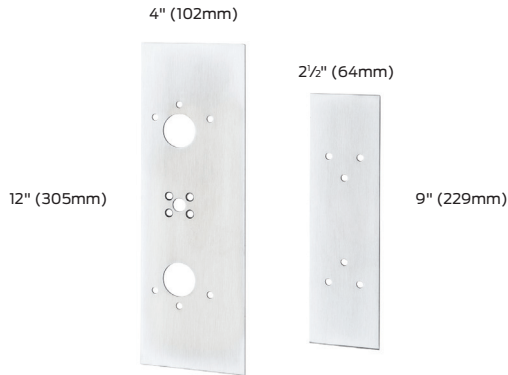

887 Kit

Required for 88 rim/8827 vertical rod device combinations on pairs of doors with ANSI 161 cutout. (The 88 rim device backset is increased and exposes the 161 cutout when used with 8827).

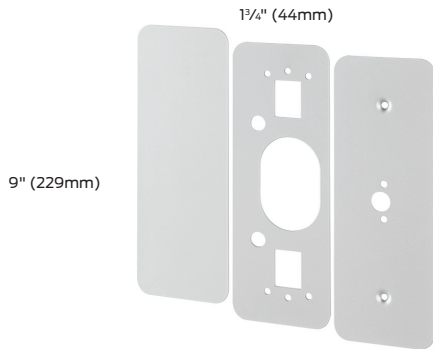

888 Kit

Required for 8875 mortise or 8827 vertical rod devices on doors with ANSI 161 cutouts (device center case will not cover stock cutout).



To order, specify:

1. Kit number.
2. Finish.
3. Device type (889 kit only).

Axle security pin

Non-removable security pin can be inserted into lever arm axle to prevent tampering or removal of lever arm.

To order, specify

Part Number 033022 (package of 50).

Controls

#10 WDA Kit

2 1/8" (52mm)

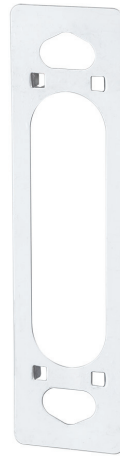

#10 WDA Kit

Required when 373L or 377T controls are used on wood doors with the following devices: 88L, 8827L, 8827TL, 8827TL-F, or 8875L (kit covers cutout and prevents control from damaging door).

889 Kit

3" (76mm)



889 Kit

Required when 373L controls are used with sex bolts (sex bolts must be used on wood or composite fire doors). Four studs on cover plate allow through-bolting to the device center case.

Additional information

UL Listed — Fire exit hardware label/opening size

Exit device	Single door	With mullion	Double door		
			Same direction vert./vert.	Same direction vert/mortise	Double egress
88-F	3 Hour 4' X 8'	3 Hour 8' X 8'	—	—	—
8875-F	3 Hour 4' X 10'	—	—	3 Hour 8' X 8'	—
8827-F	—	—	90 Min. 8' X 8'	3 Hour 8' X 8'	3 Hour 8' X 8'
8847-F	—	—	90 Min. 8' X 8'	3 Hour 8' X 8'	3 Hour 8' X 8'

ANSI Function, grade & type

Function	Grade 1 type 1	Grade 1 type 2	Grade 1 type 3	Grade 1 type 8
01	88EO, 88EO-F	8827EO, 8827EO-F	8875EO, 8875EO-F	8847EO-F
02	88DT	8827DT	8875DT	—
03	88NL, 88NL-F	—	8875NL, 8875NL-F	—
05	88TP, 88TP-F	8827TP, 8827TP-F	8875TP, 8875TP-F	—
06	—	8827TP-NL, 8827TP-NL-F		
08	88K, 88K-F, 88L, 88L-F	8827K, 8827K-F, 8827L, 8827L-F	8875K, 8875K-F, 8875L, 8875L-F	8847L-F
09	88L-NL, 88L-NL-F	8827K-NL, 8827K-NL-F, 8827L-NL, 8827L-NL-F	8875L-NL, 8875L-NL-F	8847L-NL-F
09	—	8827TL-NL, 8827TL-NL-F	—	8847TL-NL-F
11-12	—	8827TL, 8827TL-F	—	8847TL-F





Additional information

Function conversion kits

Device type	Kit	Converts from –	Converts to –	Use with trim
88	CK-NL	TP, K	NL	880NL-R
	CK-TP	EO, DT, NL, K	TP	880TP-R
	CK-K/L	EO, DT, NL, TP	K	880K-R
	CK-K/L	EO, DT, NL, TP	L	373L x 889 Plate (NL, DT, TP)
88F	CK-NL-F	TP-F, K-F	NL-F	880NL-R
	CK-TP-F	EO-F, NL-F, K-F	TP-F	880TP-R
	CK-K/L-F	EO-F, NL-F, TP-F	K-F	880K-R
	CK-K/L-F	EO-F, NL-F, TP-F	L-F	373L x 889 Plate (NL, DT, TP)
8827, 8827-F	CK27-TP	EO, DT, K (std. or fire)	TP (std. or fire)	880TP-V
	CK27-K/L	EO, DT, TP (std. or fire)	K (std. or fire)	880K-V
	CK27-K/L	EO, DT, TP (std. or fire)	L (std. or fire)	373L x 889 Plate (NL, DT, TP)
	CK27-TP-NL	EO, DT, K (std. or fire)	TP-NL	880TP-V
	CK27-K-NL	EO, DT, K (std. or fire)	K-NL	880K-V

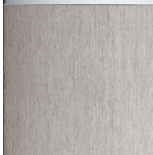
Conversion kits are required for 88 rim and 8827 devices. To convert functions on 8847 and 8875 devices, only new trim is required. The 8875 mortise lock is field convertible for function.

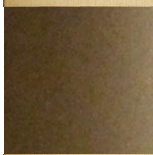
88 Series finishes

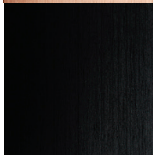
Finishes*			
Color	US Number	BHMA Number	
	Chromium, polished	US26	625
	Chromium, dull	US26D	626
	Brass, polished	US3	605
	Brass, dull	US4	606
	Bronze, dull-oxidized	US10B	613
	Bronze, dull	US10	612
	Sprayed black	SPBLK	

* **Note:** Durable powder coated finishes available at specific special request. PLEASE CONTACT FACTORY.

Notes

About Allegion

Allegion (NYSE: ALLE) is a global pioneer in safety and security, with leading brands like CISA®, Interflex®, LCN®, Schlage®, SimonsVoss® and Von Duprin®. Focusing on security around the door and adjacent areas, Allegion produces a range of solutions for homes, businesses, schools and other institutions. Allegion is a \$2 billion company, with products sold in almost 130 countries.

For more, visit www.allegion.com

KRYPTONITE ■ LCN ■  ■ STEELCRAFT ■ VON DUPRIN